

VACUUM OVENS



110 – 120 Volts



Installation - Operation Manual

SVAC1 SVAC2 SVAC4

Pictured on the front cover, left to right: SVAC1, SVAC2, SVAC4

Warning: This product contains chemicals, including triglycidyl isocyanurate, known to the State of California to cause cancer as well as birth defects or other reproductive harm. For more information, go to www.P65Warnings.ca.gov.



¡Advertencia! Este producto contiene sustancias químicas, incluido el triglicidil isocianurato, que el estado de California sabe que causa cáncer, así como defectos de nacimiento u otros daños reproductivos. Para obtener más información, visite www.P65Warnings.ca.gov.

Avertissement! Ce produit peut vous exposer à des produits chimiques, dont l'isocyanurate de triglycidyle, reconnu par l'État de Californie pour provoquer le cancer, des anomalies congénitales ou d'autres problèmes de reproduction. Pour plus d'informations, visitez le site www.P65Warnings.ca.gov.

Benchtop Vacuum Ovens

110 – 120 Voltage

Part Number (Manual): 4861835

Revision: January 14, 2020

Sheldon Part ID Numbers:

Model	SVAC1	SVAC2	SVAC4
Part ID	SLV122	SLV222	SLV422

The Part ID denotes the specific build version of the model.



SHEL LAB is a brand of Sheldon Manufacturing, INC, an ISO 9001 certified manufacturer.



Safety Certifications

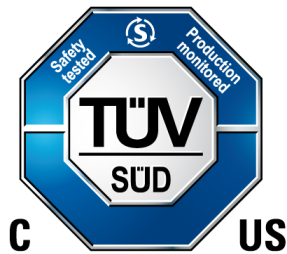

These units are CUE listed by TÜV SÜD as vacuum ovens for professional, industrial or educational use where the preparation or testing of materials is done at an ambient air pressure range of 22.14 – 31.3 inHg (75 – 106 kPa), and no flammable, volatile or combustible materials are being heated.

These units have been tested to the following requirements:

- CAN/CSA C22.2 No. 61010-1:2012
- CAN/CSA C22.2 No. 61010-2-010/2015
- UL 61010-1:2012
- UL 61010A-2-010:2015
- EN 61010-1:2010
- EN 61010-2-010:2014

TABLE OF CONTENTS

INTRODUCTION	7
<i>Read this Manual.....</i>	7
<i>Safety Considerations and Requirements</i>	7
<i>Contacting Assistance</i>	8
<i>Manufacturing Warranty</i>	8
<i>Engineering Improvements.....</i>	8
<i>Vacuum Supply Requirements.....</i>	9
<i>Reference Sensor Device</i>	10
<i>Oven Chamber Gaskets.....</i>	11
RECEIVING YOUR UNIT	13
<i>Inspect the Shipment.....</i>	13
<i>Orientation.....</i>	14
<i>Dimension Visuals.....</i>	20
<i>Record Data Plate Information.....</i>	23
INSTALLATION	25
<i>Installation Procedure Checklist</i>	25
<i>Required Ambient Conditions.....</i>	26
<i>Required Clearances.....</i>	26
<i>Power Source Requirements</i>	27
<i>Lifting and Handling</i>	28
<i>Leveling.....</i>	28
<i>Install the Oven</i>	29
<i>Deionized and Distilled Water.....</i>	29
<i>Installation Cleaning and Disinfecting</i>	29
<i>Shelving Installation.....</i>	30
<i>Connect to the Vacuum Supply</i>	32
GRAPHIC SYMBOLS	33
CONTROL OVERVIEW.....	35
OPERATION.....	37
<i>Operating Precautions.....</i>	37
<i>Theory of Operation</i>	38
<i>Put the Oven into Operation.....</i>	40
<i>Set the High Temperature Limit.....</i>	42
<i>Evacuating and Backfilling the Oven Chamber</i>	43
<i>Setting the Constant Temperature Setpoint</i>	45
<i>Temperature Programs</i>	45
<i>High Temperature Limit Activated</i>	46
<i>Changing the Unit of Measurement.....</i>	47
<i>Vacuum Gauge Operations</i>	48
<i>Maximum Obtainable Vacuum.....</i>	49
<i>Pressure Units Conversion Chart.....</i>	49
<i>Data Port.....</i>	50
<i>Oven Cooldowns.....</i>	50
USER MAINTENANCE.....	51
<i>Cleaning.....</i>	51
<i>Maintaining Atmospheric Integrity</i>	52
<i>Electrical Components.....</i>	52
<i>Vacuum Pump Maintenance.....</i>	52
<i>Storage.....</i>	52
<i>Calibrating the Temperature Display</i>	53
<i>Unlocking the Temperature Controller</i>	57
<i>Heating Issues – Diagnostic Questionnaire.....</i>	60
<i>Vacuum Leak Issues – Diagnostic Questionnaire.....</i>	65

UNIT SPECIFICATIONS 71
Weight.....71
Dimensions.....71
Capacity.....71
Shelf Capacity by Weight.....72
Vacuum.....72
Temperature.....72
Power.....73
PARTS LIST..... 75
Replacement Gaskets.....76

TABLE OF CONTENTS

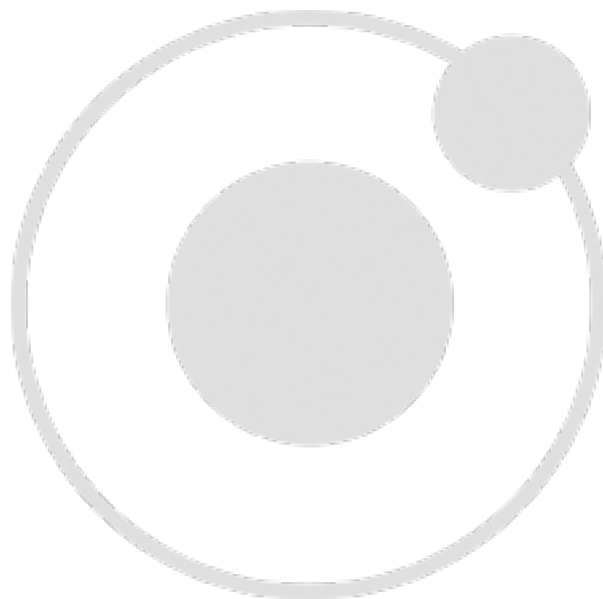

INTRODUCTION

Thank you for purchasing a SHEL LAB oven. We know you have many choices in today's competitive marketplace when it comes to constant temperature equipment. We appreciate you choosing ours. We stand behind our products and will be here if you need us.

READ THIS MANUAL

Failure to follow the guidelines and instructions in this user manual may create a protection impairment by disabling or interfering with the unit safety features. This can result in injury or death.

Before using the unit, read the manual in its entirety to understand how to install, operate, and maintain the unit in a safe manner. Ensure all users are given appropriate training before the unit begins service. Keep this manual available for use by all end-users.

SAFETY CONSIDERATIONS AND REQUIREMENTS

Follow basic safety precautions, including all national laws, regulations, and local ordinances in your area regarding the use of this unit. If you have any questions about local requirements, please contact the appropriate agencies.

SOPs

Because of the range of potential applications this unit can be used for, the end-user or their supervisors must draw up a site-specific standard operating procedure (SOP) covering each application and associated safety guidelines. This SOP must be written and available to all users in a language they understand.

Intended Applications and Locations

SVAC ovens are engineered for constant temperature drying, curing, and baking applications under vacuum in professional, industrial, and educational environments. The ovens are not intended for use at hazardous or household locations.

Power

Your unit and its recommended accessories are designed and tested to meet strict safety requirements.

- The unit is designed to connect to a power source using the specific power cord type shipped with the unit.
- Always plug the unit power cord into a protective earth grounded electrical outlet conforming to national and local electrical codes. If the unit is not grounded properly, parts such as knobs and controls can conduct electricity and cause serious injury.
- Do not bend the power cord excessively, step on it, or place heavy objects on it.
- A damaged cord can be a shock or fire hazard. Never use a power cord if it is damaged or altered in any way.
- Use only approved accessories. Do not modify system components. Any alterations or modifications to your unit not explicitly authorized by the manufacturer can be dangerous and will void your warranty.

CONTACTING ASSISTANCE

Phone hours for Sheldon Technical Support are 6 am – 4:30 pm Pacific Coast Time (west coast of the United States, UTC -8), Monday – Friday. Please have the following information ready when calling or emailing Technical Support: the **model number, serial number, part number, and Part ID** (see page 23).

support@sheldonmfg.com
1-800-322-4897 extension 4
(503) 640-3000 extension 4
FAX: (503) 640-1366

Sheldon Manufacturing, INC.
P.O. Box 627
Cornelius, OR 97113
USA

MANUFACTURING WARRANTY

For information on your warranty and online warranty registration please visit:

- sheldonmanufacturing.com/warranty

ENGINEERING IMPROVEMENTS

Sheldon Manufacturing continually improves all of its products. As a result, engineering changes and improvements are made from time to time. Therefore, some changes, modifications, and improvements may not be covered in this manual. If your unit's operating characteristics or appearance differs from those described in this manual, please contact your SHEL LAB dealer or customer service representative for assistance.

INTRODUCTION

VACUUM SUPPLY REQUIREMENTS

Pump or Building System Required

The oven does not come with a vacuum pump. **A pump must be separately purchased for the oven.**

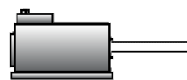

Vacuum Pump



Building Vacuum Supply

Required Flow Rate

For the oven chamber door to seal, the vacuum pump or system must be able to evacuate at least 1 cubic foot per minute (cfm) for each cubic foot of oven chamber volume (CuFt).

Model	Chamber Capacity	Min. Pump Capacity CFM	Min. Pump Capacity LPM
SVAC1	0.56 CuFt	1 cfm	28 Liters per Minute
SVAC2	1.67 CuFt	2 cfm	57 Liters per Minute
SVAC4	4.50 CuFt	5 cfm	142 Liters per Minute

The use of clamps to secure vacuum tubing is recommended.

Minimum Evacuation Level

The oven must be pumped down to **-3 inHg or lower** for the oven chamber door to seal. The manufacturer recommends pumping down below -3 inHg as part of the first step in a baking recipe to ensure a good seal. This helps safeguard the oven and pump.

Pump Type Selection

Consult a vacuum pump specialist to determine the pump type best suited to your baking application. The correct selection of a vacuum pump is critical for evacuating the chamber to the level required for your vacuum baking applications in a timely manner. The nature of the sample or product being heated should drive the selection of the pump, including the types of chemicals outgassed during the baking process. Common pump types include Chemical Duty PTFE Dry, Standard Duty Dry, and Compact Direct-Drive. The selection of an application-specific pump can improve the overall oven performance and minimize pump maintenance costs. **All maintenance and instructional information should be obtained from the pump manufacturer** if not shipped with the pump.

Oil Trap Recommended

The use of an oil trap plumbed on the vacuum line between the oven and the pump is strongly recommended. The trap protects the pump from any oils outgassed during your baking procedure. This extends the life of the pump.

INTRODUCTION

REFERENCE SENSOR DEVICE

Must be purchased separately

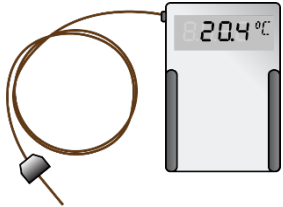

**Reference
Device**

A reference sensor device is required for calibrating the unit temperature display.

Reference devices must meet the following standards:

- Accurate to at least 0.1°C

The device should be regularly calibrated, preferably by a third party.

Temperature Probes

Use a digital device with wire thermocouple probes that can be introduced into the unit chamber through the unit access port. Select a probe suitable for the application temperature you will be calibrating at.

A vacuum-rated feedthrough baseplate is required for introducing the probe through the KF-25 port.

Why Probes?

Reference readings taken outside the chamber using wire temperature probes avoid chamber door openings. Openings disrupt the chamber temperature. Each disruption requires **a minimum 1-hour wait** to allow the chamber to re-stabilize before continuing.

No Alcohol or Mercury Thermometers

Alcohol thermometers do not have sufficient accuracy to conduct accurate temperature calibrations.

Never place a mercury thermometer in the unit chamber. Always use thermocouple probes.

OVEN CHAMBER GASKETS

Wear and Replacement

Chamber gaskets are non-warranty, high-wear consumable items subject to compression forces, heat, and outgassed byproducts. Heavy usage rates may necessitate frequent replacements. The manufacturer strongly recommends **keeping a spare gasket on hand** during operation.

Included Chamber Gasket

Each oven comes with a replaceable silicone gasket installed on the chamber liner, which seals the oven chamber when the door is closed and the chamber is under vacuum. The gasket must be replaced periodically and is rated to 230°C. It is vulnerable to acids and solvents. The manufacturer also offers for sale *Viton*[®], fluorosilicone, and Buna-N gaskets. See page 76 for information on gasket type suitability for baking applications.



Do Not Use Vacuum Grease

- These ovens do not require vacuum grease to seal.
- The use of grease may contaminate the chamber and samples and can foul vacuum pumps.
- **Silicone vacuum grease will damage silicone gaskets.** Do not use silicone grease with silicone gaskets.

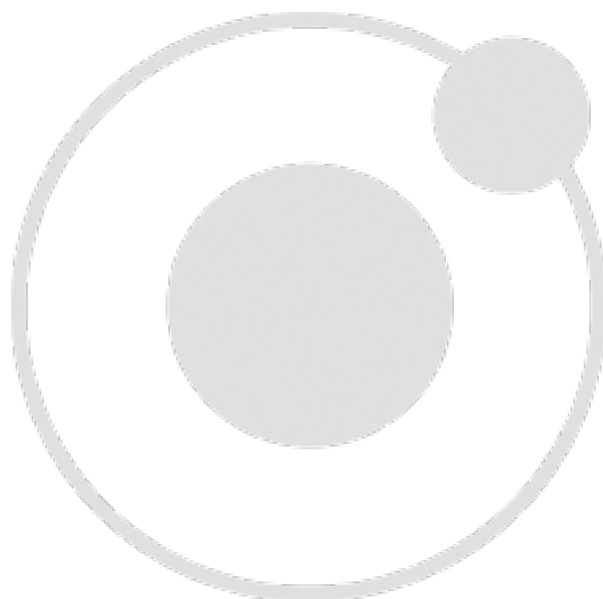

RECEIVING YOUR UNIT

INSPECT THE SHIPMENT

When a unit leaves the factory, safe delivery becomes the responsibility of the carrier. **Damage sustained during transit is not covered by the manufacturing defect warranty.** When you receive your unit, inspect it for concealed loss or damage to its interior and exterior. If you find any damage to the unit, **follow the carrier's procedure for claiming damage or loss.**

Save the shipping carton until you are certain that the unit and its accessories function properly.

1. Carefully inspect the shipping carton for damage.
2. Report any damage to the carrier service that delivered the unit.
3. If the carton is not damaged, open the carton and remove the contents.
4. Inspect the unit for signs of damage. See the orientation depictions on the next pages as a reference.
5. The unit should come with an Installation and Operation Manual and a Temperature Program Manual.
6. Verify that the correct number of accessories has been included.
7. Carefully check all packaging for accessories before discarding.

Included Accessories:

SVAC1	Tall Shelves	Short Bottom Shelf	Power Cord
	2	1	1

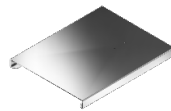
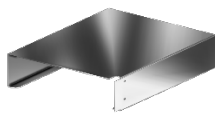

SVAC2	Tall Shelves	Short Bottom Shelf	Power Cord	Leveling Feet
	2	1	1	4

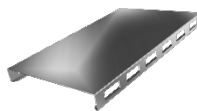
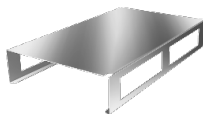

SVAC4	Shelves	Shelf Clips	Power Cord	Leveling Feet
	3	12	1	4

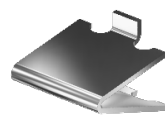
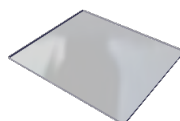

RECEIVING

ORIENTATION

SVAC4

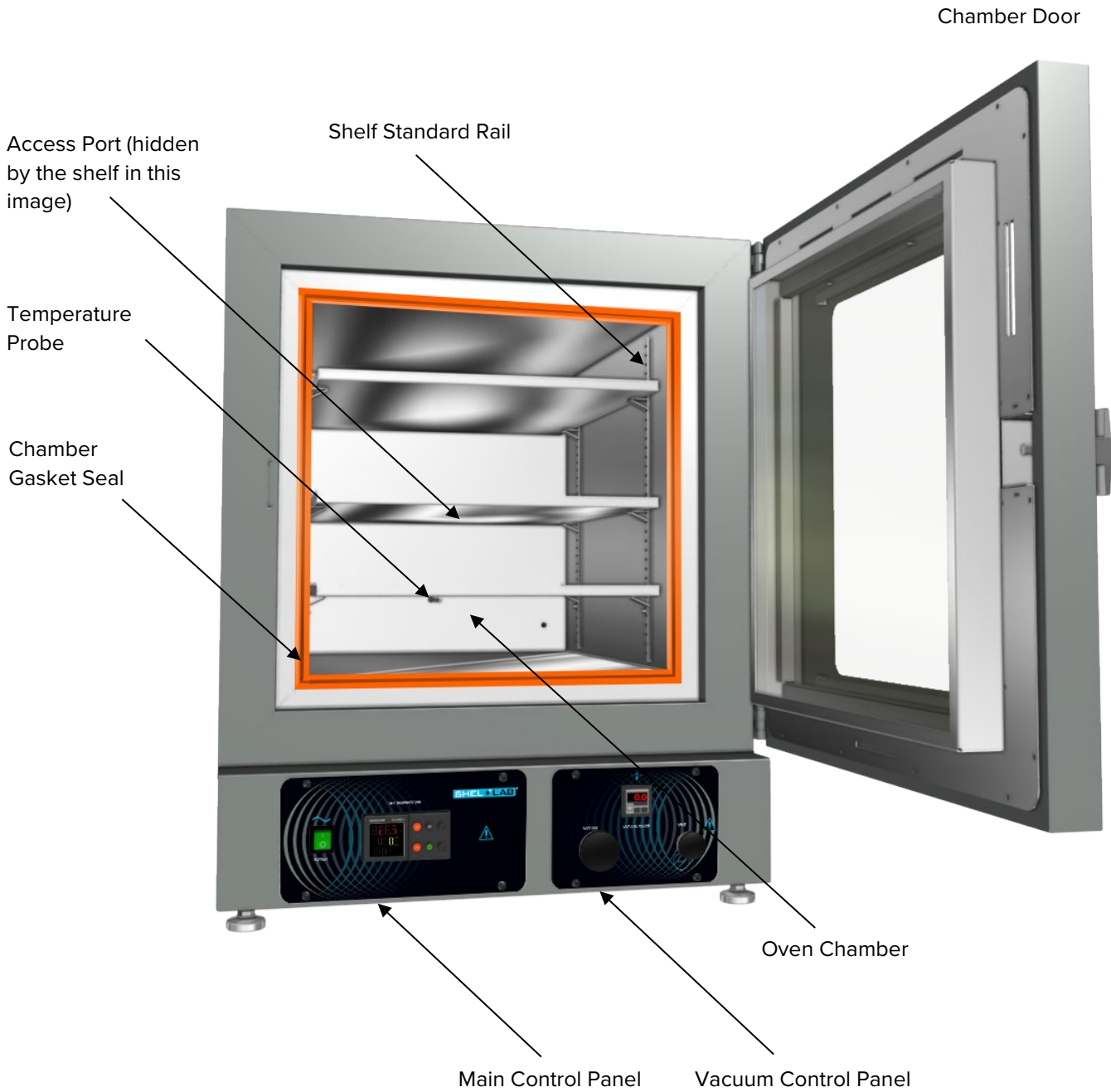

Back of SVAC4

KF-25 Access Port (Includes Blank and Clamp, not pictured here)

RS485 Data
Port 9-Pin

Vacuum Port, 3/8
inch (9.52 mm)

Chamber Vent
Inlet Port 1/4
inch (6.35 mm)

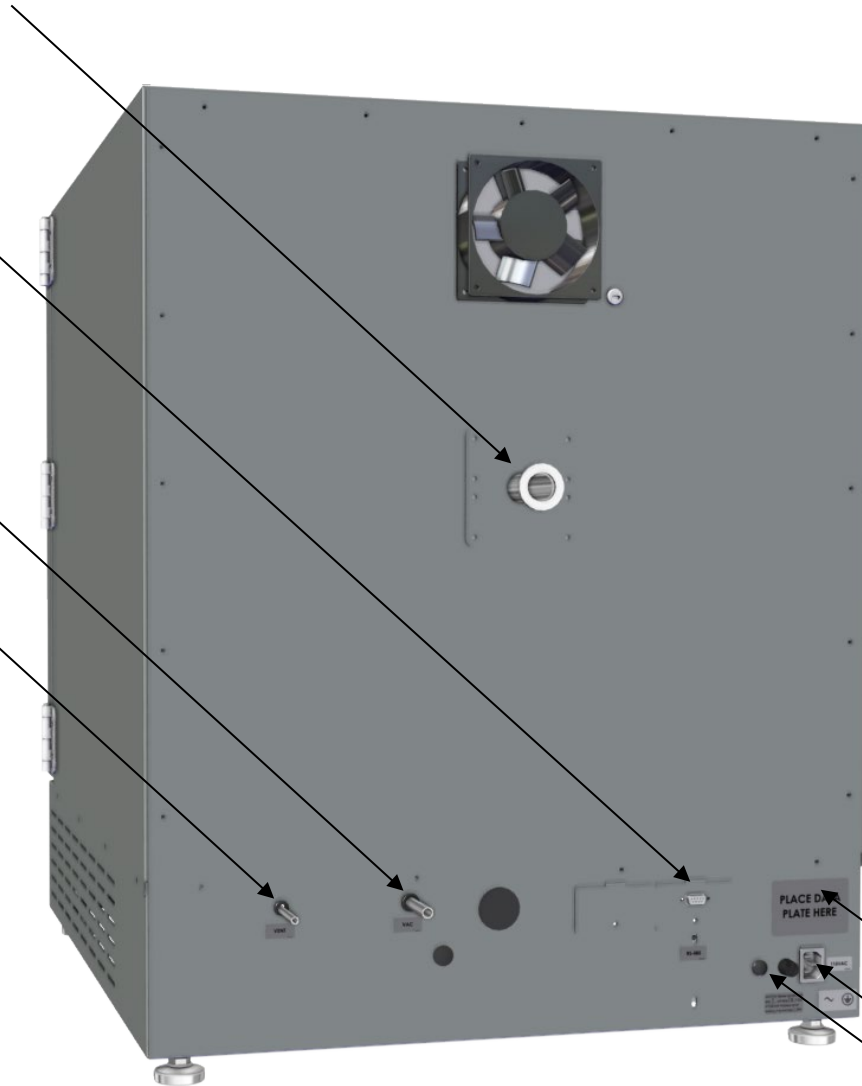

Data Plate
Power Cord
Inlet
Fuse Holder

RECEIVING

SVAC2

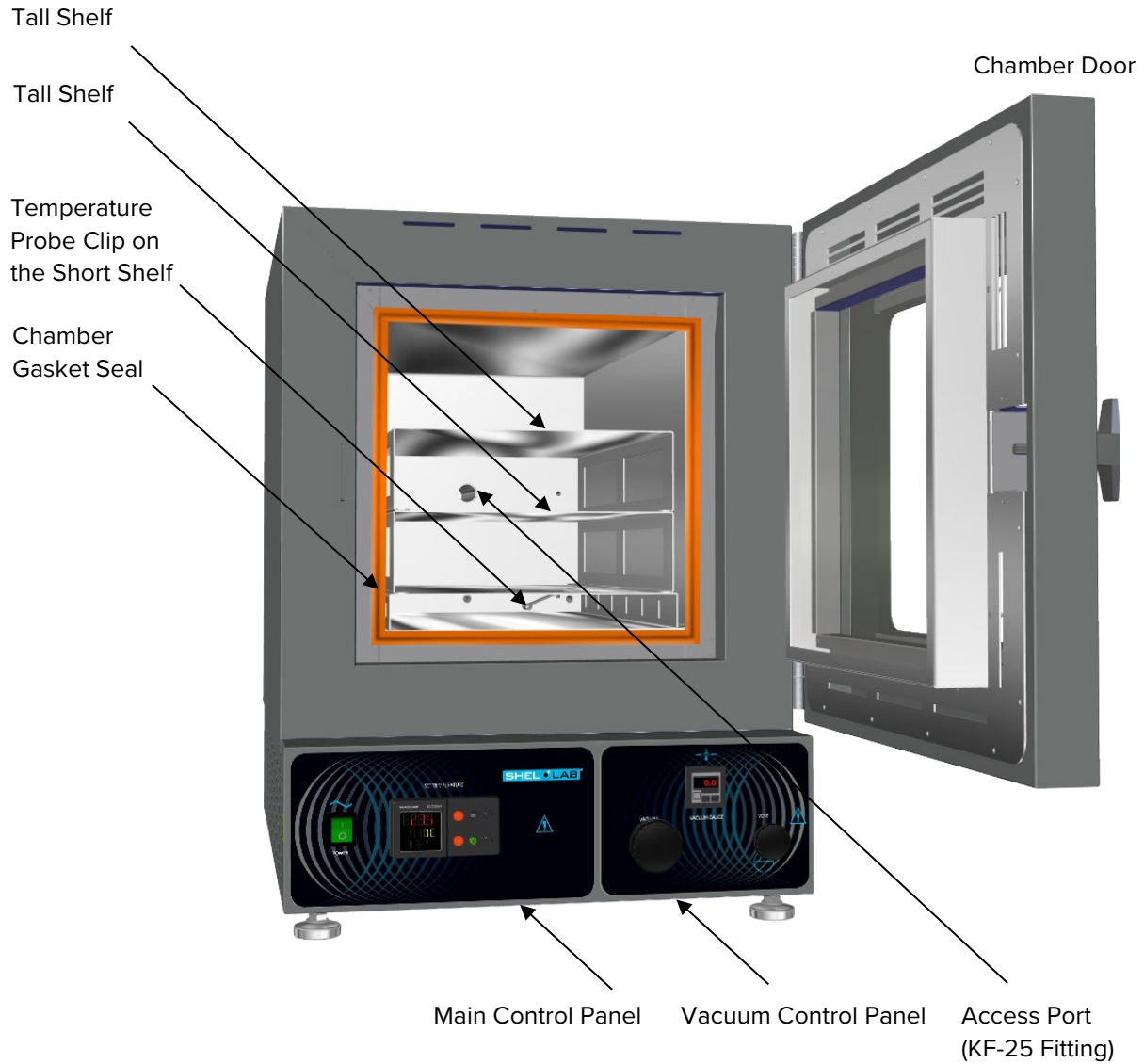

Back of SVAC2

KF-25 Access Port (Includes Blank and Clamp, not pictured here)

Vacuum Port, 3/8
inch (9.52 mm)

Chamber Vent
Inlet Port 1/4
inch (6.35 mm)

RS485 Data Port 9-Pin

PLACE DATA
PLATE HERE

Data Plate

Power Cord
Inlet

Fuse Holder

RECEIVING

SVAC1

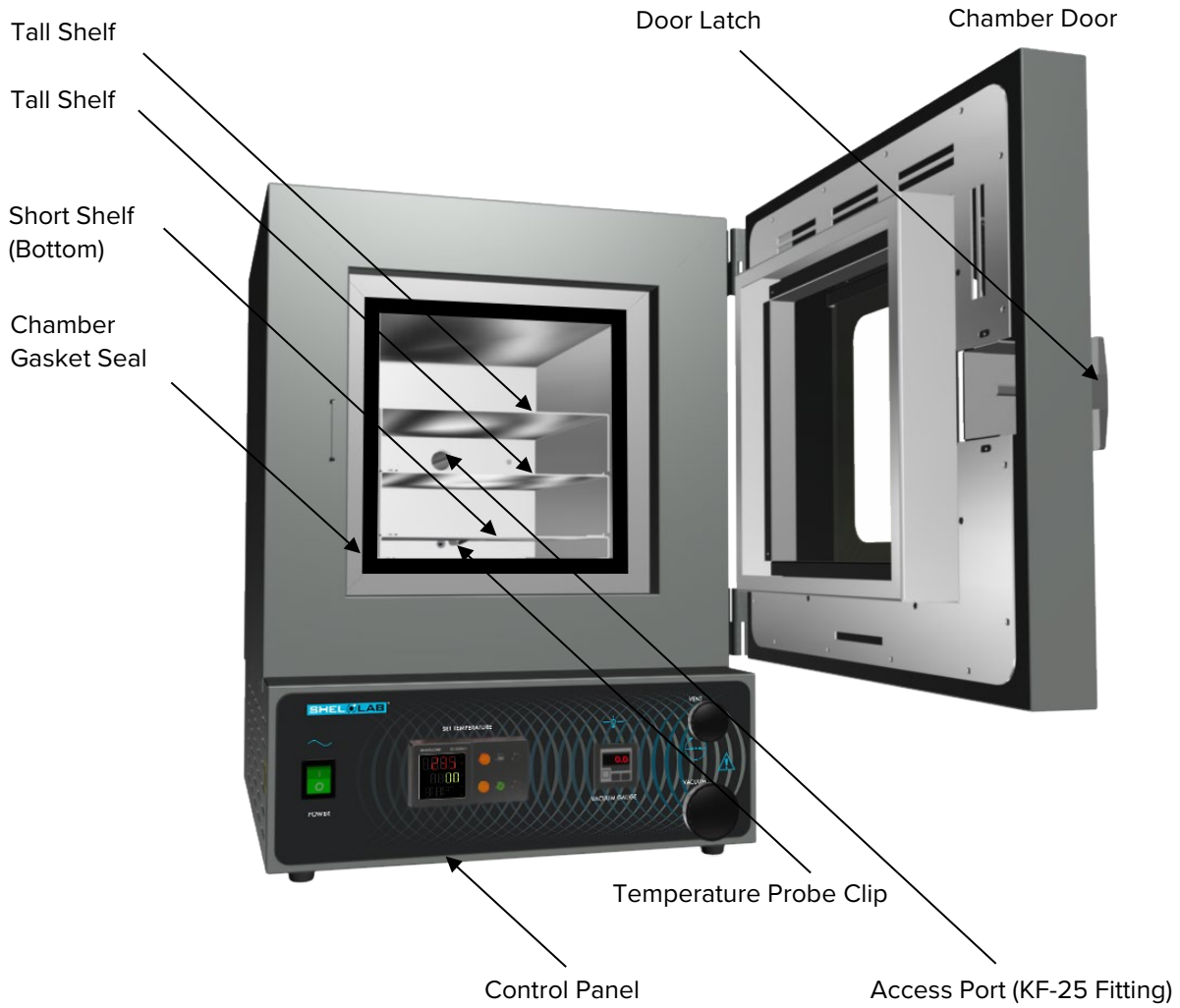

Back of SVAC1

KF-25 Access Port (Includes Blank and Clamp, not pictured here)

RS485 Data Port 9-Pin

Chamber Vent Inlet Port 1/4 inch (6.35 mm)

Vacuum Port, 3/8 inch (9.52 mm)

Data Plate
Power Cord Inlet
Fuse Holder

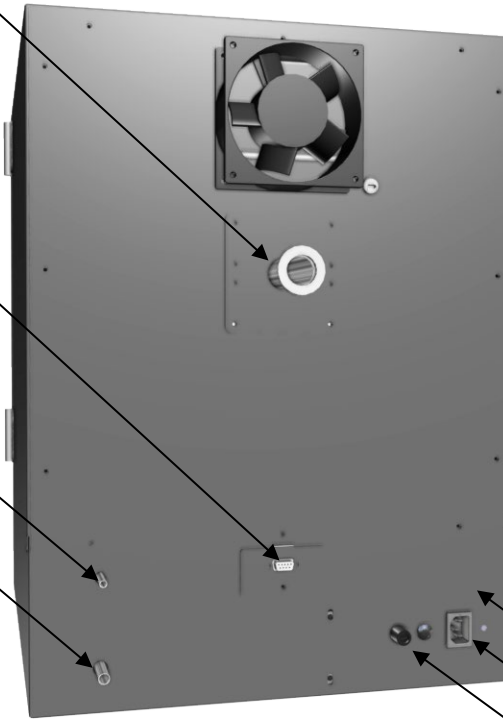

RECEIVING

DIMENSION VISUALS

SVAC4

See page 26 for the required ventilation clearances.

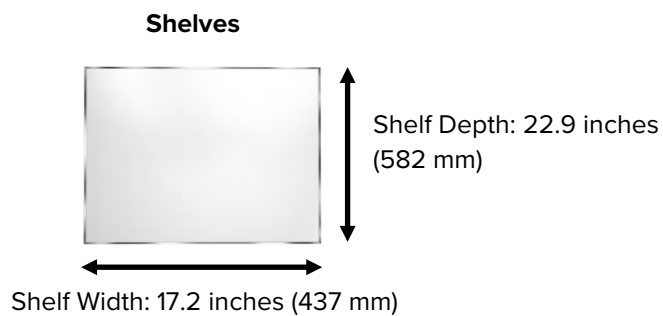
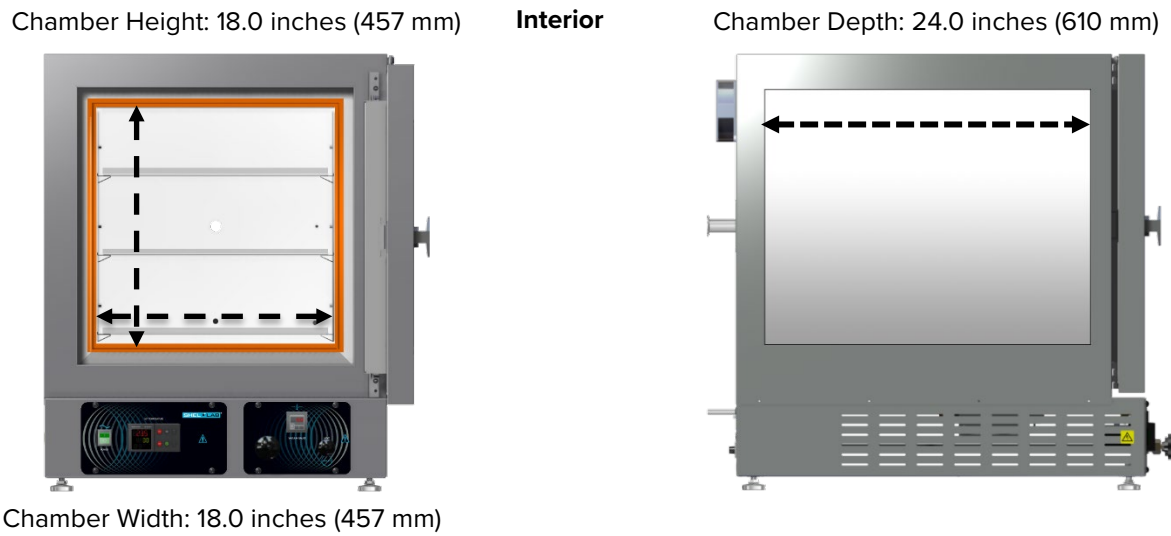
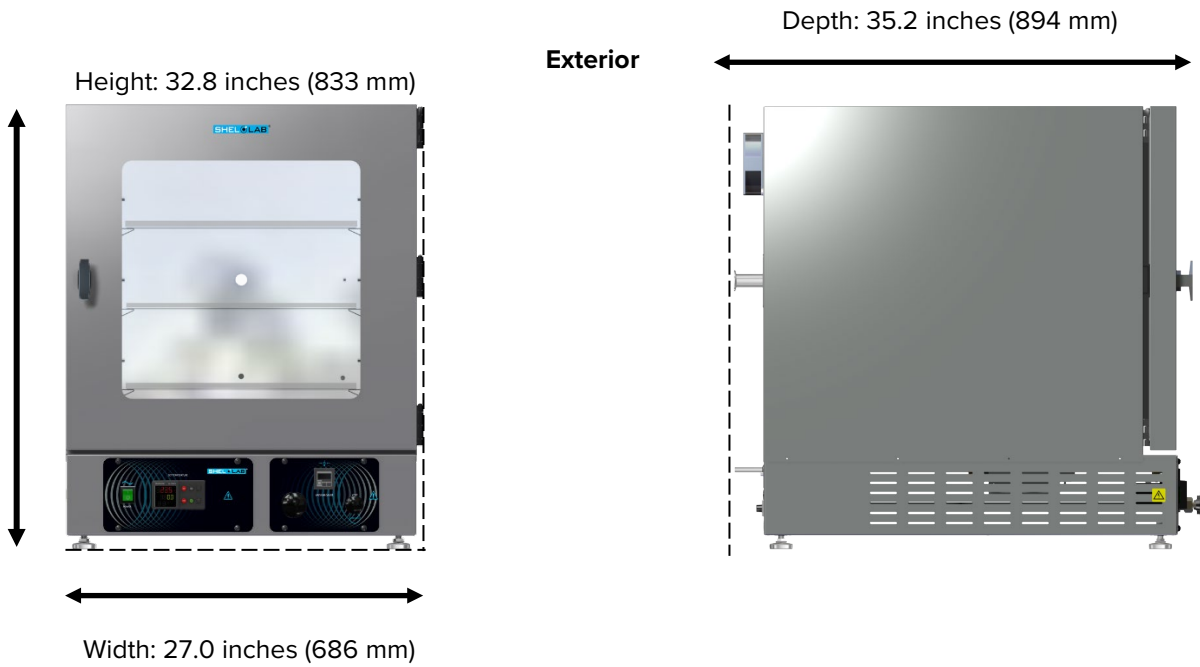

RECEIVING

SVAC2

See page 26 for the required ventilation clearances.



Exterior

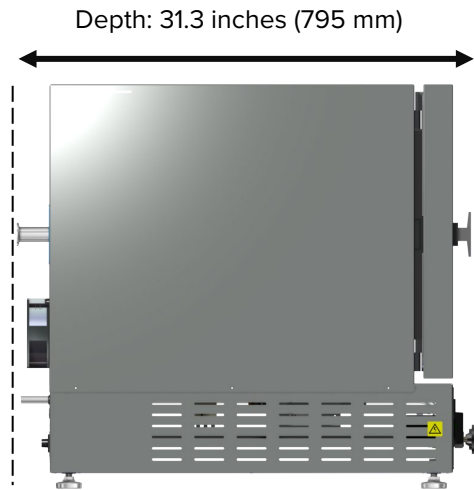

Chamber Height: 12.0 inches (304 mm)

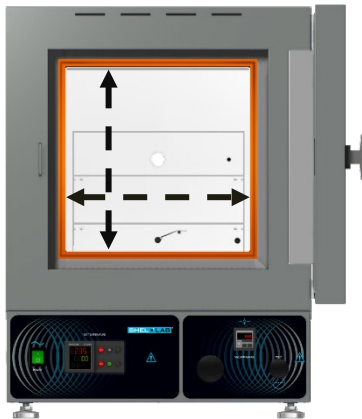

Chamber Width: 12.0 inches (304 mm)

Interior

Chamber Depth: 20.0 inches (508 mm)

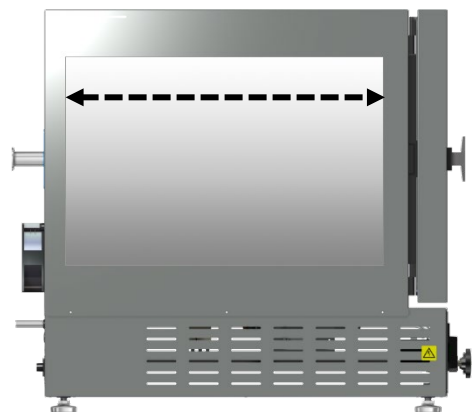

Tall Shelves



Shelf Depth: 19.0 inches (483 mm)

Shelf Width: 11.3 inches (223 mm)

RECEIVING

SVAC1

See page 26 for the required ventilation clearances.

Height: 23.7 inches (602 mm)



Exterior

Depth: 23.0 inches (584 mm)

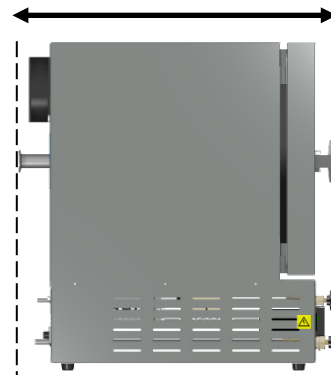

Width: 17.5 inches (444 mm)

Chamber Height: 9.0 inches (228 mm)



Interior

Chamber Depth: 12.0 inches (304 mm)

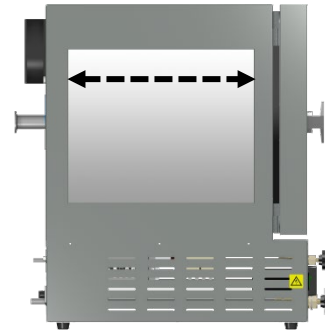

Chamber Width: 9.0 inches (228 mm)

Tall Shelves

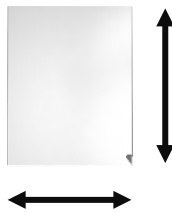

Shelf Depth: 11.0 inches
(279 mm)

Shelf Width: 8.8 inches (223 mm)

RECORD DATA PLATE INFORMATION

The data plate contains the unit **model number**, **serial number**, **part number**, and **part ID**. Tech Support will need this information during any support call. Record it below for future reference.

- The data plate is located on the back of the oven, above the power cord inlet.

Data Plate Information

MODEL NO:	
SERIAL NO:	
PART NO:	
PART ID:	

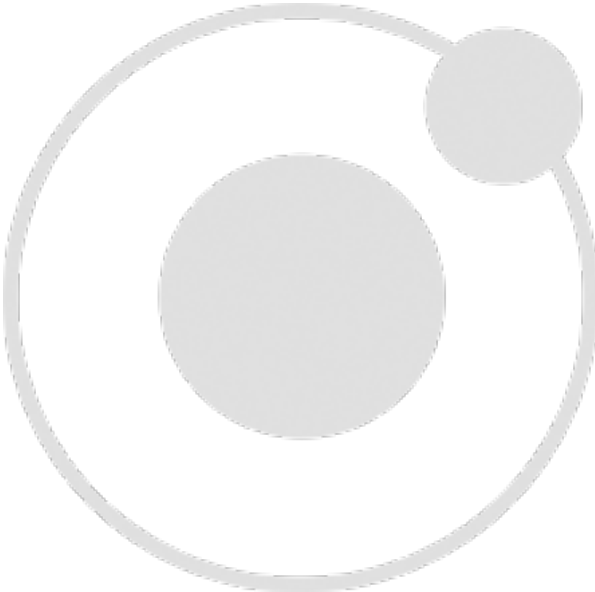

INSTALLATION PROCEDURE CHECKLIST

For installing the unit in a new workspace location.

Pre-Installation

- ✓ Verify that a vacuum supply source suitable for your application is available and can be connected to the oven, page 9.
 - See page 32 for the oven gas and vacuum port locations.
- ✓ Check that the required ambient conditions for the unit are met, page 26.
- ✓ Check that the spacing clearance requirements are met, page 26.
 - Unit dimensions may be found on page 71.
- ✓ Check that a suitable electrical outlet and power supply is present, page 27.

Install the oven in a suitable workspace location

- ✓ Review the lifting and handling instructions, page 28.
- ✓ SVAC2 and SVAC4, install the leveling feet, page 28.
- ✓ Install the oven in its workspace location, page 29.

Set up the oven for use

- ✓ Clean the oven shelving. Clean the chamber if needed, page 29.
- ✓ Install the shelving in the oven chamber, page 30.
- ✓ Connect the oven to its vacuum supply source along with any optional backfill gas supply, page 32.

INSTALLATION

REQUIRED AMBIENT CONDITIONS

This oven is built for use indoors at room temperatures between **15°C and 40°C (59°F and 104°F)**, at no greater than **80% Relative Humidity** (at 25°C / 77°F). The ambient temperature should not change by 2°C (3.6°F) or more during operation.

Operating outside these conditions may adversely affect the oven temperature performance.

When selecting a location to install the unit, consider all environmental conditions that can adversely impact its temperature performance. These include:

- Proximity to other ovens, autoclaves, and any device that produces significant radiant heat
- Heating and cooling vents or other sources of fast-moving air currents
- High-traffic areas
- Direct sunlight

REQUIRED CLEARANCES

These clearances are required to provide airflows for ventilation and cooling.

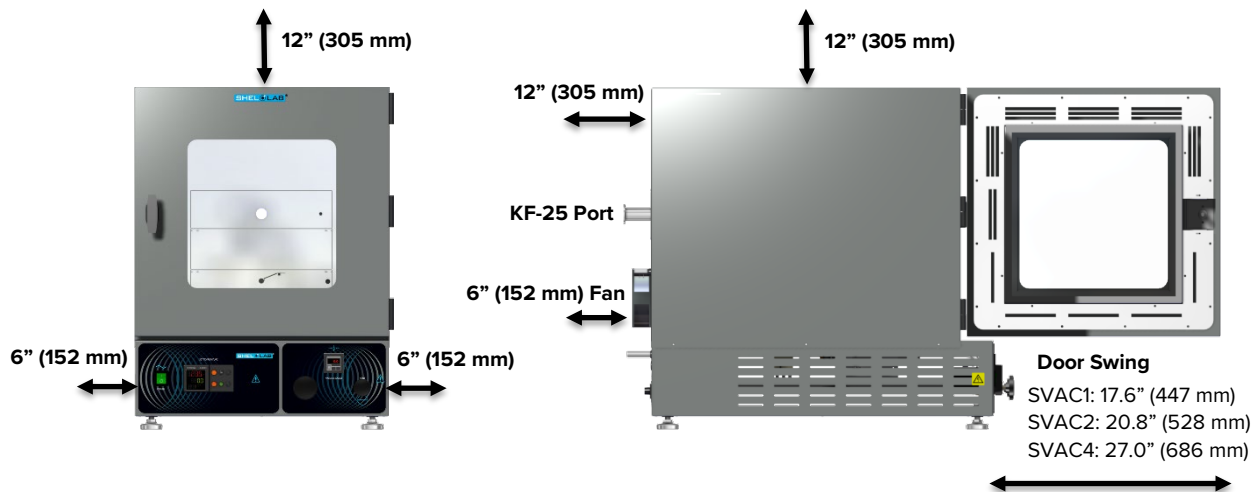

6 inches (152 mm) of clearance is required on the sides.

12 inches (305 mm) of headspace clearance is required between the top of the unit and any overhead partitions.

Do not place objects on top of the oven.

A KF-25 vacuum port is located on the back of the oven for introducing vacuum-rated thermocouple feedthroughs into the chamber or connecting to an external vacuum supply source. Leave sufficient clearance for users to safely access this port.

INSTALLATION

POWER SOURCE REQUIREMENTS

When selecting a location for the unit, verify each of the following requirements is satisfied.

Power Source: The wall power outlet must meet the power requirements listed on the unit data plate.

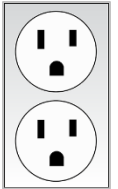

Model	AC Voltage	Amperage	Frequency
SVAC1	110 – 120	7.0	50/60 Hz
SVAC2	110 – 120	10.0	50/60 Hz
SVAC4	110 – 120	13.0	50/60 Hz

- **Supplied voltage must not vary more than 10% from the data plate rating.** Damage to the unit may result if the supplied voltage varies more than 10%.
- The wall power source must be protective earth grounded.
- Use a separate circuit to prevent loss of the unit due to overloading or circuit failure.
- **The recommended wall circuit breakers for these units are 15 amps.**
- The wall power source must conform to all national and local electrical codes.

Power Cord

The unit must be positioned so that all end-users can quickly unplug the oven in the event of an emergency.

- Each unit comes provided with a **125-volt, 15-amp, 9ft 5 in (2.86 m) NEMA 5-15P** power cord.
- Always use this cord or an identical replacement.



Fuses

Each unit comes with a fuse installed in a fuse holder immediately adjacent to the power cord inlet.

- The fuse must be installed and intact for the unit to operate.
- Always find and fix the cause of a blown fuse prior to putting the unit back into operation.
- Fuse type:
 - T16A 250V 5x20mm



INSTALLATION

LIFTING AND HANDLING

The oven is heavy. Use appropriate lifting devices that are sufficiently rated for these loads. Follow these guidelines when lifting the oven:

- Lift the oven only from its bottom surface.
- Doors, handles, and knobs are not adequate for lifting or stabilization.
- Restrain the oven completely while lifting or transporting so it cannot tip.
- Remove all moving parts, such as shelves and trays, and lock doors in the closed position during transfers to prevent shifting and damage.

LEVELING

All ovens must be level and stable for safe operation.

SVAC2 and SVAC4: Install the 4 leveling feet in the 4 corner holes in the bottom of the oven.

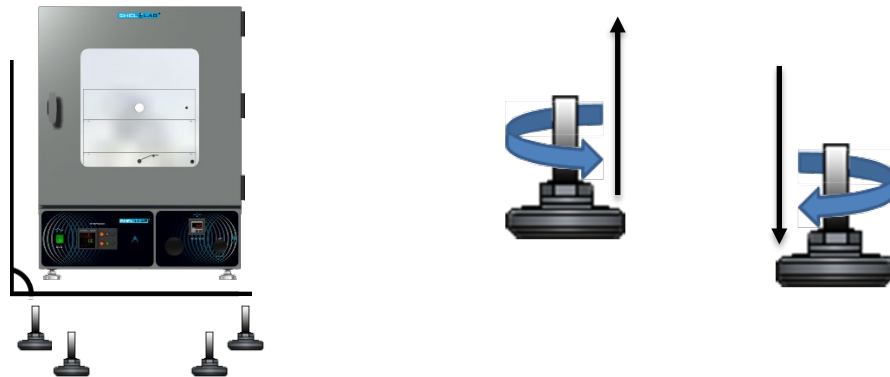

Note: To prevent damage when moving the unit, turn all 4 leveling feet so that the leg of each foot sits inside the unit.

SVAC1: The rubber leveling feet are non-adjustable.

INSTALL THE OVEN

Install the unit in a workspace location that meets the criteria discussed in the previous entries of the Installation section.

- Do not connect the oven to its power source at this time.

DEIONIZED AND DISTILLED WATER

Do not use deionized water to clean the unit, even if DI water is readily available in your laboratory.

- The use of deionized water may corrode metal surfaces and **voids the manufacturing warranty**.
- The manufacturer recommends the use of distilled water in the resistance range of 50K Ohm/cm to 1M Ohm/cm, or a conductivity range of 20.0 uS/cm to 1.0 uS/cm, for cleaning applications.

INSTALLATION CLEANING AND DISINFECTING

The manufacturer recommends cleaning the shelving and oven chamber prior to the installation of the shelving in the chamber. The unit was cleaned at the factory but may have been exposed to contaminants during shipping.

- Remove all wrappings and coverings from shelving prior to cleaning and installation.
- See the [Cleaning and Disinfecting](#) topic in the User Maintenance section (see page 51) for more information on how to clean the oven chamber and shelving.
- **Do not clean with deionized water.**

INSTALLATION

SHELVING INSTALLATION

In a pumped down oven chamber, heat flows in part from oven elements through the chamber walls and floor and into the shelves. Install the shelves as described below to ensure proper heat conduction and temperature measurement in a vacuum environment.

Never place samples or products on the oven chamber floor. The floor runs hotter than the shelf temperatures. All oven heating specifications are for shelving temperatures.

SVAC1 and SVAC2

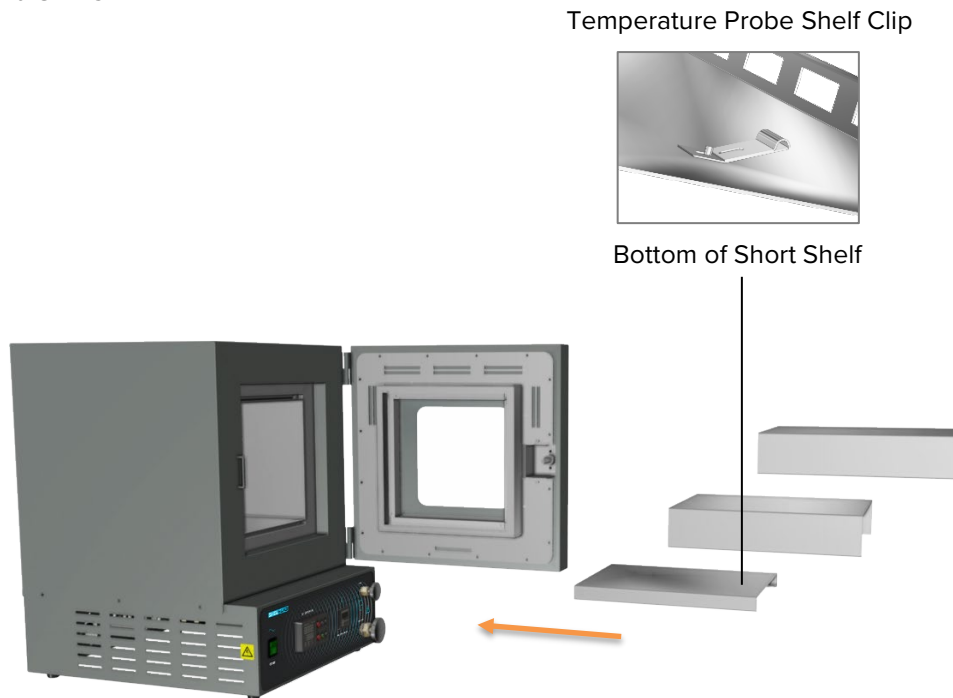

1. Carefully slide the short shelf into position on the chamber floor, sliding the clip on the bottom of the shelf onto the oven temperature probe.

- The shelf clip should be on the side of the shelf closest to the oven door. This ensures the best measurement position for the probe.
- The oven probe extends from the back wall near the floor of the chamber.
- **The short shelf must be on the bottom** of the shelf-stack to ensure the oven accurately measures and controls the shelving temperature.

2. Place the 2 tall shelves on top of the short shelf.

Continued on next page

INSTALLATION

Shelving Installation Continued

SVAC4 Shelving

To ensure accurate temperature measurement, **one shelf bottom must be in close proximity to the oven temperature probe**. This probe extends out from the chamber back wall. Do not place the shelf in direct contact with the probe.

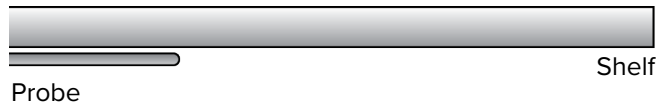
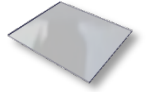

Install 4 Shelf Clips



Rocking Motion

Place the Shelf

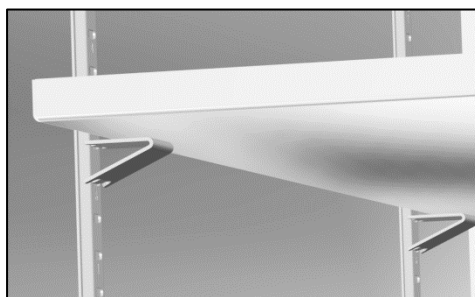

1. Install the shelf clips in the slots of the shelf standard mounting rails located on the sides of the chamber interior, 4 clips per shelf.
 - a. Squeeze each clip, insert the top tab first, and then the bottom tab using a rocking motion.
2. Set the shelves on the clips.
 - a. Verify the shelves are level.

INSTALLATION

CONNECT TO THE VACUUM SUPPLY

Use clamps to secure the tubing to the Vacuum and Vent Ports.

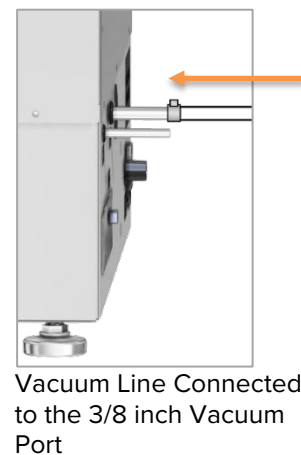
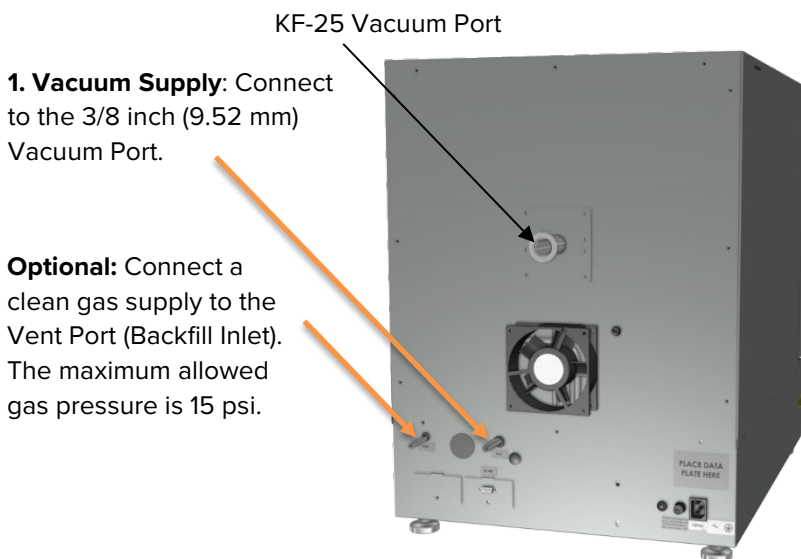







Vacuum and Gas Backfill Connections

Oven Chamber Ports – Left to Right

- **Vent Port (Backfill Inlet)** – 1/4 inch (6.35 mm) OD
 - External atmosphere backfills the oven chamber through this port when the Vent Valve control on the front control panel is opened.
 - A clean or inert gas supply source may be connected to this port. **The maximum allowed delivery pressure at the port is 15 psi.**
- **Vacuum Port** – 3/8 inch (9.52 mm) OD
 - The chamber atmosphere is evacuated through this port. Connect the vacuum source to the oven here.
 - This port is opened and closed by the Vacuum Valve control on the front control panel.
- **KF-25 Vacuum Port**
 - Comes with a clamp and blank.
 - Used for introducing thermocouple probes through a vacuum-rated feedthrough.
 - A vacuum supply can be connected to the KF-25 port for increased efficiency in vacuuming down the chamber. However, the Vacuum Valve control on the front control panel will not affect the level of vacuum and must be set to Closed to prevent atmosphere from entering the chamber through the 3/8-inch Vacuum Port.

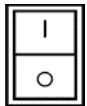
GRAPHIC SYMBOLS

The unit is provided with graphic symbols on its exterior. These identify hazards and adjustable components as well as important notes in the user manual.

Symbol	Definition
	Consult the user manual Consulter le manuel d'utilisation
	Over Temperature Limit system Thermostat température limite contrôle haute
	AC Power Repère le courant alternatif
	I/ON O/OFF I indique que l'interrupteur est en position marche. O indique que le commutateur est en position d'arrêt.
	Potential shock hazard Risque de choc électrique
	Recycle the unit. Do not dispose of in a landfill. Recycler l'unité. Ne jetez pas dans une décharge
	Protective earth ground Terre électrique

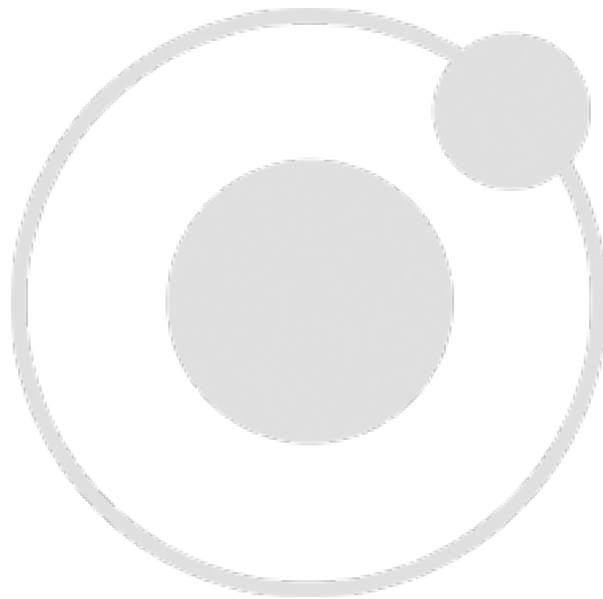

CONTROL OVERVIEW

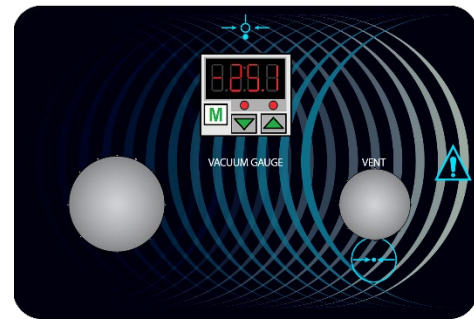

Control Panels

Power Switch

The switch illuminates when in the ON (I) position.



Temperature Controller - Display on Homepage



Top Line (Red): Present chamber shelving temperature

Middle Line (Green): The constant temperature setpoint

Bottom Line: Flashing "2" indicates active heating

While on the homepage, the **Up** and **Down** arrow buttons adjust the constant temperature setpoint. Pressing and holding both buttons navigates from the homepage to menu pages. On the menu pages, the buttons adjust calibration offsets and temperature program variables.



When starting on the homepage, the green **Advance** button navigates forward through parameter option pages including and Units of Measurement (Celsius or Fahrenheit). The button also advances forward in menus and parameter lists when programming a temperature recipe in the oven controller.



The gray **Reset** button returns the display to the previous page or menu. Pushing the Reset button repeatedly returns the display to the homepage.



The EZ1 button launches temperature Program 1. Pushing EZ1 again while running aborts Program 1.



The EZ2 button launches temperature Program 2 (Step 11). Pushing EZ2 again while running aborts Program 2.



CONTROL OVERVIEW

Vacuum Gauge

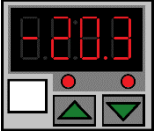

As set at the factory, this gauge shows the chamber vacuum level relative to sea level atmospheric pressure in inches of mercury (inHg). The display range is 0 to -29.9inHg. Zero is the room atmosphere pressure at sea level and -29.9inHg a near-perfect vacuum. See page 48 for how to display other units of measurement or zero the gauge to your local altitude.

Vacuum Valve Control

This valve adjusts the level of vacuum draw applied to the oven chamber through the Vacuum Port on the back of the oven.

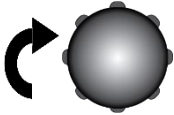

Close

- In the **open** position, this valve allows the connected vacuum supply to pump down the oven chamber.
- In the **closed** position, the valve closes off the vacuum draw.

This valve should always be closed before a vacuum pump attached to the oven is turned off. This safeguards the pump from external atmosphere being drawn through it and into the oven. If an attached oil pump is turned off while the valve is open and the chamber is under vacuum, oil may be pulled out of the pump and into the oven.

Vent Valve Control (Chamber Backfill)

This valve controls the oven chamber inlet Vent Port on the back of the oven.

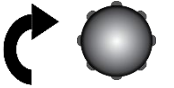

Close

- In the **open** position, the oven chamber is open to external atmosphere through the vent intake port on the back of the oven.
- Optional: An inert or clean backfilling gas supply connected to the Vent Port will flow gas from the pressurized supply to the oven chamber when the Vent Valve is open.
- When the valve control is in the **closed** position, the chamber is cut off from external atmosphere and any backfill gas supply.
 - **The vent must be closed before pumping down the chamber.** Failure to do so may result in damage to the vacuum pump.

Safe operation of the oven depends on the actions and behavior of the oven end-user. **Operating personnel must read and understand the Operating Precautions in this section prior to operating the oven.** The end-user must follow these instructions to prevent injuries and to safeguard their health, environment, and the materials being treated in the oven, as well as to prevent damage to the oven. Failure to adhere to the Operating Precautions, deliberately or through error, is a hazardous behavior on the part of the end-user.



Le fonctionnement sûr du four dépend des actions et du comportement des opérateurs du four. Le personnel d'exploitation doit lire et comprendre les consignes de sécurité et les précautions d'utilisation de cette section avant d'utiliser le four. Les opérateurs doivent suivre ces instructions pour prévenir les blessures et protéger leur santé, leur environnement et les matériaux traités dans le four, ainsi que pour éviter d'endommager le four. Le non-respect des consignes de sécurité et des précautions d'utilisation, délibérément ou par erreur, est un comportement dangereux de la part de l'opérateur.



OPERATING PRECAUTIONS

- Do not use this oven in unsafe improper applications that produce flammable or combustible gases, vapors, liquids, or fuel-air mixtures in quantities that can become potentially explosive.
- Outgassed byproducts may be hazardous to or noxious for operating personnel. Vacuum pump exhaust should be vented to a location outside the workspace in a safe manner in accordance with all applicable laws, ordinances, and regulations. Do not operate the oven in an unsafe area with noxious fumes.
- Do not use this oven for applications heating hazardous fibers or dust. These materials can become airborne and come into contact with hot surfaces.
- Individual ovens are not rated to be explosion proof. Follow all building certification requirements and laws for Class I, II, or III locations as defined by the US National Electric Code.
- The bottom surface of the chamber should not be used as a work surface. It runs hotter than the shelf temperatures. Never place samples or product on the oven chamber floor.
- Do not place sealed or filled containers in the oven. These may burst open when the chamber is under vacuum.
- Do not place alcohol or mercury thermometers in the oven. With improper use, they can rupture.
- Do not move the oven until it has finished cooling.

Burn hazard: Use proper personal protective equipment to minimize the risk of burns when the oven door is open and the chamber door interior, chamber surfaces, and shelving are hot.

Risques de brûlure: Utilisez un équipement de protection individuelle approprié pour minimiser le risque de brûlures lorsque la porte du four est ouverte et que l'intérieur de la porte de la chambre, les surfaces de la chambre et les étagères sont chauds.



THEORY OF OPERATION

Vacuum



Vacuum is supplied by an external vacuum supply (a pump or building system) connected to the vacuum port on the back of the oven. Vacuum levels obtained in the oven chamber are dependent on pump type and performance, valve settings, and the nature of the application or process, including the volume of materials outgassed.

The chamber atmospheric pressure is displayed on the Vacuum Gauge on the main control panel.

The chamber should be sealed and evacuated at the start of a vacuum baking application. The oven is not built to operate with the chamber exposed to atmosphere. Running the oven with the door or the vent open risks destroying the vacuum pump, damaging the integrity of the oven chamber, and may oxidize chamber surfaces.

Vacuum pumps and door gaskets should be selected on the basis of the application type or process. Pumps vary in suitability and safety depending on the outgassed byproduct types and moisture levels produced in the oven chamber. Gasket types are both resistant to and vulnerable to different chemicals.

Gas Backfill



A gas or clean air supply can be connected to the vent port (backfill inlet) or KF-25 port located on the back of the oven. Nitrogen or other inert gases are typically used to avoid particulate contamination or the oxidation of product that has not cooled down. The maximum allowed backfill pressure is 15 psi of delivery at the port.

Heating Options



The oven can either heat to and run at a constant temperature setpoint or execute a programmable multistep temperature program with ramp up, heat soak, and ramp down intervals.

Heating in a Vacuum

In conventional ovens, powered elements transfer heat into the chamber air. The heated air then circulates by natural convection or blower fan action and surrounds the product on the shelves, gradually bringing it to temperature. In a vacuum oven, heat transfer takes place in part through direct infrared radiation. A significant portion, however, takes place through conduction. The oven heating elements located inside the chamber walls and floor transfer heat to the shelves via metal-on-metal conduct. Each shelf then transports heat to the products or samples resting on it.



The displayed oven temperature may change when pumping down the oven. This reflects the chamber probe transitioning from measuring air temperature to shelf temperature, followed by a redistribution of thermal energy in the vacuum environment. This may present as a drop in temperature followed by an apparent rise. The drop may take place even if the oven is actively heating.

Heating Control

The controller monitors the oven chamber shelving temperature using a thermocouple temperature probe extending into the chamber from the back wall. In a vacuum environment, the probe senses the temperature of the shelf placed immediately above it. Placement of a shelf in close proximity to – but not in contact with the probe – is crucial for accurate measurement of the shelving temperature in the vacuum chamber.

The unit uses Proportional – Integral – Derivative (PID) control to avoid significantly overshooting the setpoint. The rate of heating will slow as the chamber temperature approaches the target temperature. If the chamber temperature is above the setpoint, the unit uses minimum heating to control the rate of cooling and avoid dipping below the setpoint.

PID loops also optimize heating rates to compensate for the temperature environment around the unit. If the unit is operating in a cool room, the controller will increase the length of the heating pulses. Likewise, when operating in a warm room the unit uses shorter pulses. If the ambient temperature conditions change significantly, there may be minor over or undershoots as the unit adapts.

The oven relies on natural heat radiation for cooling. It can achieve a low-end operating temperature of the ambient room temperature plus the oven waste heat.

High Limit Control System

The temperature controller contains a heating cutoff system with independent circuitry connected to a redundant solid-state temperature sensor probe inside the oven chamber. This high limit system depowers the oven heating elements whenever the chamber shelving temperature exceeds the current limit setting. This safeguards the oven in the event of a failure of the main temperature control circuitry or main temperature sensor probe.

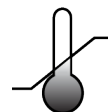

The high limit is set by the end-user to a minimum of 10°C above the highest temperature of the application process the oven is currently being used for. Failure to set the high limit control system voids the oven manufacturing defect warranty in the event of an overtemperature event.

OPERATION

PUT THE OVEN INTO OPERATION



Perform the procedures below after the unit has been installed in a new workplace location. These verify the integrity of the vacuum system and prepare the oven for normal use.

1. Attach the Power Cord



Attach the power cord that came with the unit to the power inlet receptacle on the back of the oven.

2.



Plug the power cord into the workspace electrical supply.

3. Verify the Door and Valves are Closed

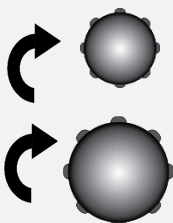

Verify the oven **chamber door** is **closed and latched**, and that the **vent intake valve and vacuum valve** are in the **closed position** (turned all the way clockwise).

This safeguards your vacuum pump from exposure to streaming atmosphere.

4. Turn on the Oven

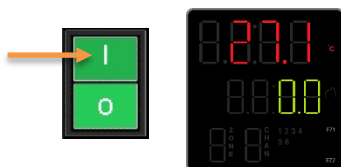

Place the oven **Power Switch** in the ON (I) position.

- The controller display will illuminate and default to its homepage.
- The vacuum display will illuminate.

5. Set the High Limit Temperature



Use the [Set the High Temperature Limit](#) procedure on page 42 to set to the Limit heating cutoff at least 10°C above the highest intended temperature of your application.

6. Plug in the Vacuum Pump



Plug the vacuum pump power cord into a wall power source.

Continued next page

OPERATION

Continued from the previous page

7. Verify Vacuum Integrity

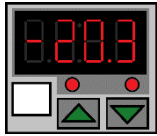

10 Minutes Minimum

Use the **Evacuating the Chamber** procedure on page 43 to pump down and hold the oven chamber under vacuum for 10 minutes to verify the integrity of the vacuum supply system.

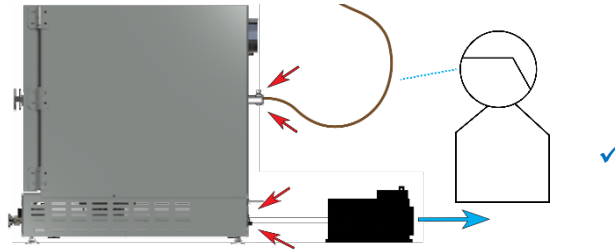

8. Setting the Operating Temperature

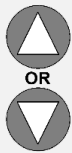

Read these procedures and descriptions.

Set the constant temperature setpoint. See the procedure on page 45.

Or

Program multistep heating recipes. See the description on page 45.



The oven is now ready for use

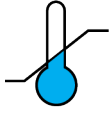

SET THE HIGH TEMPERATURE LIMIT

Note: Test the high limit system once per year for functionality.

Set the high-temperature limit at least 10°C above the highest temperature the oven will run at during your recipe program or constant-temperature application. See the High Temperature Limit system explanation on page 39.

1. Advance to the Limit High Setpoint, starting on the homepage



Push Advance
Multiple Times



Push the Advance button until “Lh.S1” (Limit High Setpoint) shows in the green mid-level display line.

2. Adjust the high limit to at least 10°C above the highest temperature of your application



Adjust



- The oven will automatically save and apply the new High Limit setting after you have stopped adjusting.

Note: If you are just checking the current high-temperature limit setting, push the Reset button to exit the Limit High Setpoint menu and return to the homepage without saving any changes.

3. Return to the homepage



Push Reset



- Returned to homepage

End of Procedure

OPERATION

EVACUATING AND BACKFILLING THE OVEN CHAMBER

The oven chamber must be drawn down to at least -3 inHg (-76 mmHg or -10 kPa) in order to seal.

Option 1: Vacuuming down with a pump connected to the vacuum port.

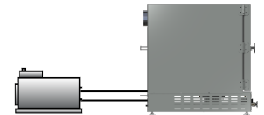

Evacuate the Oven Chamber

1. Verify the Vacuum and Vent Valve controls are in the closed position

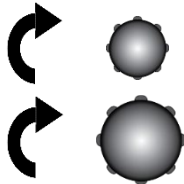

- This protects your vacuum pump from exposure to streaming atmosphere.

2. Turn on your vacuum pump

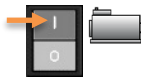

3. Open the oven Vacuum Valve

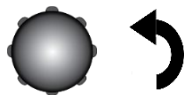

VACUUM

Turn the control all the way counterclockwise.

- The Vacuum Gauge on the front panel should show the chamber pressure decreasing.
- The achievable vacuum level is dependent on altitude above sea level as well as the vacuum supply efficiency and the volume of outgassed byproducts. See page 49.

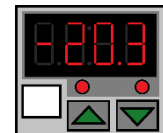

Holding at Vacuum



Continue evacuating the chamber throughout the baking application to vent outgassed byproducts.

Backfilling the Oven Chamber

4. Close the Vacuum Valve

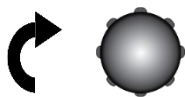

VACUUM

Turn the Vacuum Valve control back to the closed position (clockwise) to protect the vacuum pump from extended exposure to streaming atmosphere.

- The pump may remain on.

5. Slowly open the Vent Valve



VENT

The chamber pressure gauge will count upward to 0 inHg.

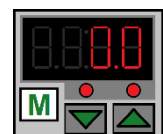

End of Procedure

OPERATION

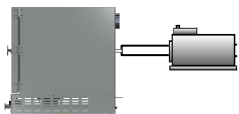

Option 2: Vacuuming down with a vacuum supply connected to the KF-25 fitting on the back of the oven.



Evacuate the Oven Chamber

1. Verify the Vacuum and Vent Valve controls are in the closed position

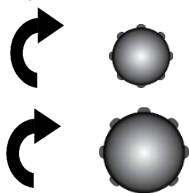

- This protects your vacuum pump from exposure to streaming atmosphere.

2. Turn on your vacuum pump

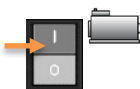

3. Open the regulator on your vacuum supply system

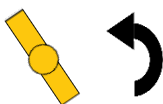

- The vacuum gauge should show a decreasing pressure in the oven chamber.

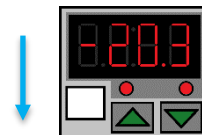

Holding under Vacuum



- Continue evacuating the chamber throughout the baking application to vent outgassed byproducts.
- When first putting the oven into operation, hold under vacuum for at least ten minutes.

Backfilling the Oven Chamber

4. Close the regulator on your vacuum supply system.

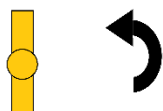

- This isolates your pump from the oven chamber.

5. Slowly open the Vent Valve



VENT

- The chamber pressure gauge will count upward to 0 inHg.

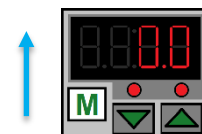

End of Procedure

SETTING THE CONSTANT TEMPERATURE SETPOINT



1. Adjust the constant temperature setpoint on the homepage

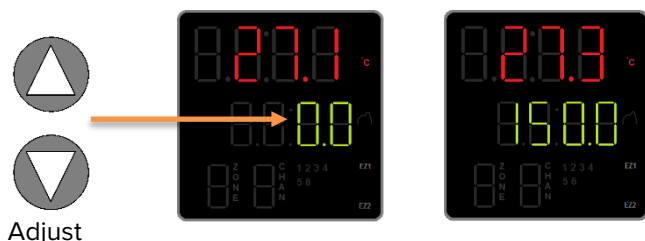

- Stay 10°C below the high limit setpoint.

Note: Holding down an arrow button will cause the temperature to advance in increments of ten (10).

2. Release the arrow buttons after adjusting the setpoint



Oven Heating

- There may be a brief pause as the oven controller calculates the optimum power usage to achieve the setpoint starting from the current oven chamber temperature.
- A small illuminated 2 near the bottom of the display indicates the temperature controller is calling for heat.

TEMPERATURE PROGRAMS

Please see the temperature program manual included with this oven for how to program automated heating recipes. The manual provides illustrated explanations for all major program functions and programming steps.



Pushing EZ1 launches heating Program 1. Pushing EZ1 again while running aborts Program 1.



Pushing EZ2 launches heating Program 2 (Step 11). Pushing EZ2 again while running aborts Program 2.





HIGH TEMPERATURE LIMIT ACTIVATED

The High Limit system cuts off heating in the oven whenever the chamber temperature meets or exceeds the Limit setting. Heating remains disabled until the oven end-user clears the Limit cutoff.

Indicators

When heating is cut off, the oven display flashes an alert screen alternating with the homepage. Additionally, an illuminated “4” on the bottom display level specifies that the oven should be routing electricity away from the heating elements.

Activation of the Limit cutoff is accompanied by a click sound.

Possible Causes of High Limit Activation

- The oven temperature is set above or near the High Limit cutoff setting. The High Limit should be set **at least 10°C above** the highest intended temperature of your heating application.
- A heat source in the oven chamber is pushing the oven temperature above the limit setting.
- Significant outgassing in the chamber may be interfering with the measured temperature.
- Attempting to heat a significant mass of product or samples may trigger a temperature overshoot and subsequent Limit cutoff.
- The oven temperature controller circuitry or sensor probe have failed.

If you suspect an ignition event in the oven chamber or a hardware failure **wait for the oven to cool to room temperature before opening the chamber door**. Contact [Technical Support](#) for assistance.

Clearing the High Limit Heating Cutoff

- Clearing the cutoff restores power to the oven heating elements.
- The oven chamber temperature must be below the High Limit cutoff setting before clearing the cutoff.
- Always verify it is safe to resume heating before clearing the High Limit cutoff.

1. Push the Reset button.



- The alert screens will flash 2 additional times before the oven controller clears the cutoff, ending it.

Alternating Screens



Attention Screen



Heating Off

°C → °F

CHANGING THE UNIT OF MEASUREMENT

The controller can display temperatures in either Celsius or Fahrenheit.



1. Starting on the homepage, push the green Advance button until reaching the “C_F1” units of measurement option.



2. Use the Arrow buttons to change the measurement parameter on the top display line to your preferred unit of measurement.

- “C” is Celsius and “F” Fahrenheit.



3. Push the Reset button to save and return to the homepage.



VACUUM GAUGE OPERATIONS

Change the Unit of Measurement



1. Place the vacuum gauge in its adjustment mode.

a. Press and hold the “M” button for approximately 3 seconds.

- The display will begin to blink and show a unit of measurement.



2. Use the arrow buttons to scroll between units.



3. Exit the adjustment mode.

a. Press and hold the “M” button for approximately 3 seconds.

- The display will cease blinking and show the current chamber pressure.

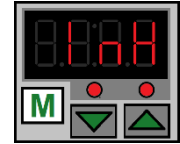

Inches of Mercury

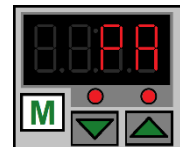

Kilopascals

Units of Measurement – Display Characters

kPa	Kgf/cm ²	bar	psi	mmHg	inHg	mmH ₂ O
0.000	0.000	0.000	0.000	0.000	0.000	0.000

Zeroing the Gauge

As set at the factory, the vacuum gauge shows a reading of 0 inches of mercury (inHg) when the chamber is at ambient (room) pressure. The display was set near sea level.

If the gauge does not show 0 inHg when the chamber is at room atmospheric pressure, perform the following steps to zero the gauge.



Both

1. **With the chamber door open**, press and hold both the **Up** and **Down** arrow buttons.

2. Release the buttons when the display shows 0.0.

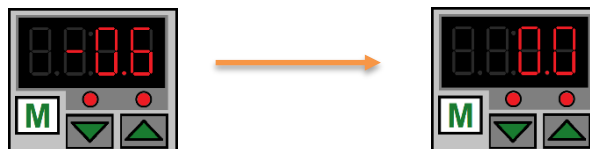

See page 72 for the zero equivalent for units of measurement other than inHg.

MAXIMUM OBTAINABLE VACUUM

The maximum vacuum obtainable, **as measured by the oven gauge**, is in part a function of altitude. While a vacuum pump will evacuate the same percentage of atmosphere from the oven chamber at higher altitudes, less **overall pressure** is expelled because of the reduced density.

Put differently, at sea level, there are 29.9 inches of mercury pressure that can be drawn out of the oven chamber by a vacuum pump. At 5000ft (1524m), there are only 24.9 inches of atmospheric pressure to be evacuated from the oven chamber.

Altitude (Feet)	Altitude (Meters)	Atmospheric Pressure	Max Vac Obtainable
Sea Level	Sea Level	14.70 psi	-29.9 inHg
1000ft	305m	14.16 psi	-28.9 inHg
2000ft	610m	13.66 psi	-27.8 inHg
3000ft	914m	13.16 psi	-26.8 inHg
4000ft	1219m	12.68 psi	-25.8 inHg
5000ft	1524m	12.22 psi	-24.9 inHg
6000ft	1829m	11.77 psi	-24.0 inHg
7000ft	2134m	11.33 psi	-23.1 inHg
8000ft	2438m	10.91 psi	-22.2 inHg
9000ft	2743m	10.50 psi	-21.4 inHg
10,000ft	3048m	10.10 psi	-20.6 inHg

*In gauge pressure

PRESSURE UNITS CONVERSION CHART

	InHg	kPa	Kgf/cm ²	bar	psi	mmHG	mmH ₂ O
1 inHg	1	3.3863	0.0345	0.3386	0.4911	25.400	345.32
1 kPa	0.2953	1	0.0102	0.01	0.1450	7.5006	101.97
1 Kgf/cm ²	28.9590	98.0665	1	0.9806	14.2233	735.55	10000.27
1 bar	29.5300	100	1.0197	1	14.5037	750.06	10197.44
1 psi	2.0360	6.8947	0.0703	0.0689	1	51.7150	703.09
1 mmHG	0.0394	1.3332	0.0014	0.0013	0.0193	1	13.5954
1 mmH ₂ O	0.0028	0.0098	0.0001	0.0001	0.0014	0.0029	1

DATA PORT



9-Pin Port

The 9-pin RS485 data port, located on the back of the oven, connects to the oven temperature controller. The port is primarily intended for updating the controller software but can be used for data logging and graphical temperature recipe programming. Accessing the controller with a computer requires a 9-pin RS485-to-USB converter cable and driver software.

Applications and Utility Software

- **National Instrument LabView** and **Watlow SpecView** — Temperature monitoring and data logging in graphical user interface environments.
- **Watlow's EZ Zone™ Configurator** — Programming temperature recipes in a drop-down menu environment. Configurator can also be used to copy and save the controller configuration file, which includes the currently programmed heating programs.
 - Configurator is available for free on the Watlow website.

OVEN COOLDOWNS

The oven chamber is well insulated and requires a significant amount of time to cool down while sealed and evacuated. Please see the Unit Specifications chapter for cooldown times.

- Introducing free atmosphere into the oven when the chamber temperature is above 100°C risks oxidizing chamber surfaces.
- Backfilling the oven with N₂ does not significantly increase the rate of cooling.

Warning: Disconnect the unit from its power supply prior to maintenance or cleaning of this unit.

Avertissement: Avant d'effectuer toute maintenance ou entretien de cet appareil, débrancher le cordon secteur de la source d'alimentation.



CLEANING

If a hazardous material or substance has spilled in the unit, immediately initiate your site Hazardous Material Spill Containment protocol. Contact your local Site Safety Officer and follow instructions per the site policy and procedures.

- Periodic cleaning is required.
- Do not use spray-on cleaners or disinfectants. These can leak through openings and coat electrical components.
- Do not use cleaners or disinfectants that contain solvents capable of harming paint coatings or stainless steel surfaces. **Do not use chlorine-based bleaches or abrasives; these will damage the chamber liner.**
- Consult with the manufacturer or their agent if you have any doubts about the compatibility of decontamination or cleaning agents with the parts of the equipment or with the material contained in it.

Warning: Exercise caution if cleaning the unit with alcohol or flammable cleaners. Always allow the unit to cool down to room temperature prior to cleaning and make sure all cleaning agents have evaporated or otherwise been completely removed prior to putting the unit back into service.

Avertissement: Soyez prudent lorsque vous nettoyez l'appareil avec de l'alcool ou des produits de nettoyage inflammables. Laissez toujours refroidir l'appareil à la température ambiante avant le nettoyage et assurez-vous que tous les produits de nettoyage se sont évaporés ou ont été complètement enlevés avant de remettre l'appareil en service.



Oven Chamber Cleaning Guidelines

1. Disconnect the unit from its power supply.
2. Remove any removable chamber accessory items such as shelving if present.
3. Use 99% isopropyl alcohol to clean chamber surfaces and shelving. Apply using lint-free wipes.
4. Take special care when cleaning around temperature sensor probes. Do not clean the probes.
5. Clean all removable accessories and components.
6. Verify the cleaning alcohol has evaporated completely from all chamber surfaces and accessories prior to reconnecting the unit to its power source.

Oven Exterior Cleaning Guidelines

1. Disconnect the unit from its power supply.
2. The manufacturer recommends cleaning the unit with a mild soap and water solution.
 - **Do not use abrasive cleaners**, these will damage metal surfaces.
 - Cleaning agents must be compatible with steel and powder coat paint surfaces.
 - Do not use deionized water to rinse or clean with.
3. Rinse with distilled water and wipe dry with a soft cloth.

MAINTAINING ATMOSPHERIC INTEGRITY

Periodically, inspect the door latch, trim, catch, and gasket for signs of deterioration. Failure to maintain the integrity of the door system shortens the lifespan of the unit.

The gasket should be replaced if it is dry, cracked, or otherwise showing a loss of elasticity.

ELECTRICAL COMPONENTS

Electrical components do not require maintenance. If the oven fails to operate as specified, please contact your distributor or [Technical Support](#) for assistance.

VACUUM PUMP MAINTENANCE

Refer to the operation manual supplied with your vacuum pump for recommended maintenance routine, such as oil levels, replacement of sorbent charge, and exhaust filter change-outs. **Contact your vacuum pump supplier if you do not have an operation manual.**

STORAGE

To prepare the unit for storage, remove all shelves, dry the chamber completely, and disconnect the power supply. Be certain that the door is positively locked in the closed position.

CALIBRATING THE TEMPERATURE DISPLAY

Note: Performing a temperature display calibration requires a temperature reference device. Please see the [Reference Sensor Devices entry](#) on page 10 for device requirements.

Temperature calibrations match the temperature display to the actual chamber temperature inside the oven chamber. The actual chamber temperature is supplied by a reference sensor device. Calibrations compensate for software drifts in the controller as well as those caused by the natural material evolution of the sensor probe in the chamber space. Calibrate as often as required by your laboratory or production protocol, or regulatory compliance schedule. Always calibrate to the industry or regulatory standards required for your application.

A Suggested Calibration Set-Up

1. Introduce the reference device vacuum-rated thermocouple probe feedthrough into the KF-25 port on the back of the oven.

- There must be at least 12 inches (305 mm) of wire in the chamber to prevent heat sinking, which would result in a false low temperature reading.

2. Position the probe in the chamber.

- Place the probe head as close as possible to the geometric center point of the chamber.
- The probe head must be in direct contact with the shelf surface.

3. Secure the probe head in position with the non-marking, heat-resistant tape.

4. Use the KF-25 clamp to secure the feedthrough and seal the port.

5. Close and latch the oven door. The door must be sealed to carry out an accurate calibration.

6. Evacuate the chamber to the vacuum level of your application or baking process. The chamber must be under vacuum to perform an accurate calibration.

Use non-marking, heat-resistant polyamide tape to hold the thermocouple probe in place. The oven manufacturer recommends Kapton brand tape, 0.5 inches width (12.7 mm), 2 mil thickness.

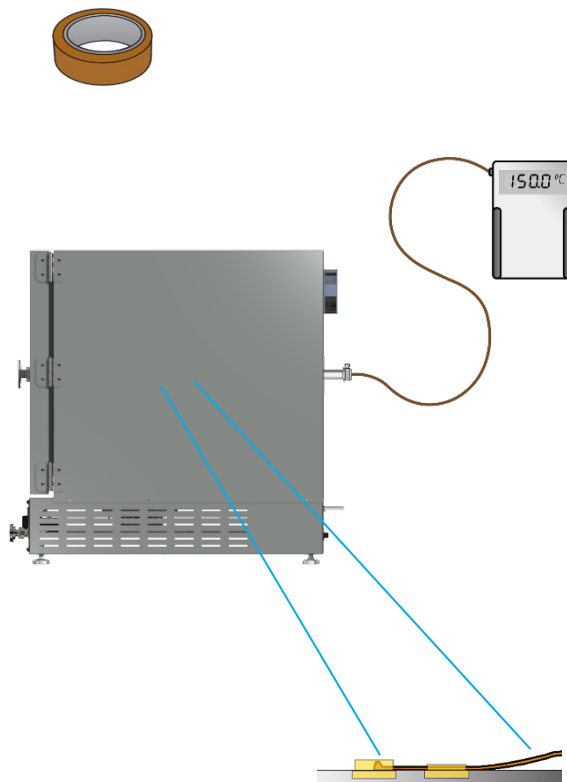

Probe head in direct contact with the shelf surface

MAINTENANCE

7. The unit temperature must be stable in order to perform an accurate calibration.

- The temperature is considered stabilized when the oven chamber has operated at your calibration temperature for at least 1 hour with no fluctuations greater than the specified temperature stability of the oven (see the Unit Specifications chapter).
- The manufacturer recommends calibrating at your application temperature.

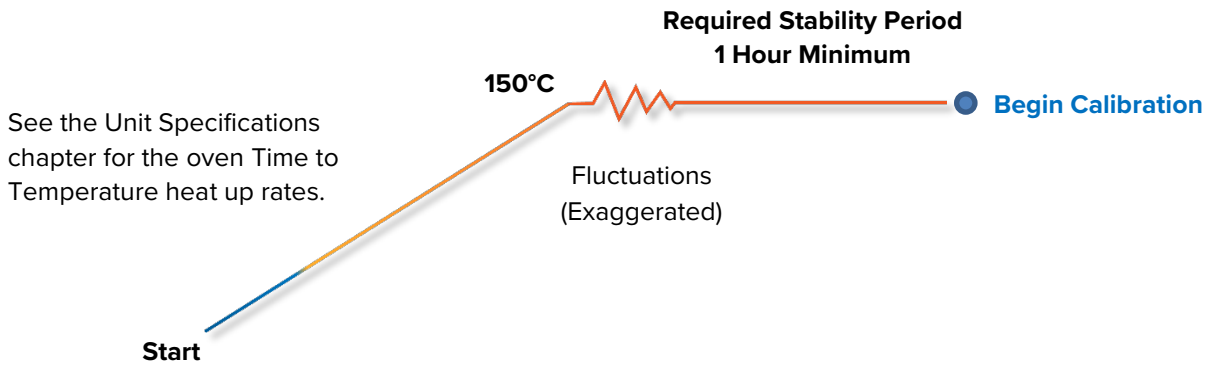

Suggested Calibration Procedure

1

Once the chamber has stabilized, compare the reference temperature device and chamber temperature display readings.

- If the readings are the same, or the difference between the two falls within the acceptable range of your protocol, the display is accurately showing the chamber temperature. **The Temperature Calibration procedure is now complete.**

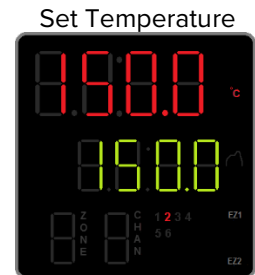

-OR-

- See the next step if a difference falls outside the acceptable range of your protocol.

2

The display requires a calibration adjustment.

- The difference between the reference device and the display is an **offset value**.
- Examples of offset values:

Reference Sensor Reading	Oven Temp. Display	Offset Value
152.0°C	150°C	2
149.1°C	150°C	-0.9
148.0°C	150°C	-2

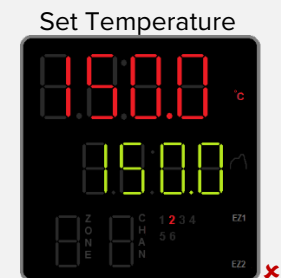

Note the offset value for use in Step 5.

Continued next page

MAINTENANCE

Calibration continued

3

Unlock the controller.

- See the Unlocking procedure on page 57.

Note: The temperature controller must be unlocked in order to access the Operations menu and enter a calibration offset.



4

Navigate to the Operations menu after unlocking the controller.



- Press and hold both the **Up** and **Down** arrow buttons simultaneously for approximately 5 seconds.
- Release the buttons when “A1” appears on the top display line and “oPEr” appears in the mid display line.

Note: The Operations menu will not appear if the controller is not unlocked.



Operations Menu

5

Advance through the Operations menu options to the Temperature Calibration offset parameter.



- Push the green **Advance** button repeatedly until “i.CA” appears in the green mid display line and a number value in the red top line.



6

Adjust the number value in the top display line to match the offset value from step 2, using the arrow buttons.



7

Save the calibration offset and return to the homepage.



- Push the **Reset** button 3 times so the display shows the homepage.
 - The oven will now begin heating or passively cooling to reach the setpoint with the corrected display value.

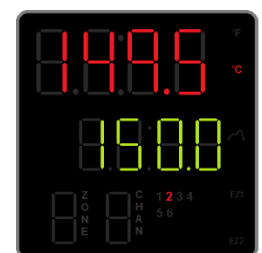

Continued next page

Calibration continued

8

Wait for 30 minutes for the oven to stabilize, **after the oven has achieved the setpoint** with the corrected display value.



Wait 30 Minutes

- Failure to wait until the oven is fully stabilized will result in an inaccurate reading.

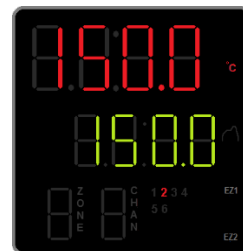

9

Compare the reference device reading with the chamber display again.

- If the reference device and the chamber temperature display readings are the same, or the difference falls within the range of your protocol, **the unit is now calibrated for temperature.**

-OR-

- See the next step if the readings still fail to match or fall outside of your protocol range.

Reference Device



10

If the two readings are not the same, and the difference still falls outside the acceptable range of your protocol, repeat steps 3 - 7 up to two more times.

- You may skip Step 3 by leaving the controller unlocked until the unit is successfully calibrated.
- Three attempts may be required to successfully calibrate units that are more than $\pm 2^{\circ}\text{C}$ out of calibration.

Note: Always relock the temperature controller after a successful calibration has been carried out. This safeguards against a user accidentally changing the controller configuration file and interfering with the functionality of the unit.

Reference Device



If the temperature difference between the unit and reference device readings fall outside your protocol after three calibration attempts, contact Technical Support or your distributor for assistance.

End Calibration Procedure

UNLOCKING THE TEMPERATURE CONTROLLER

The oven temperature controller is software locked at the factory to ensure the integrity of its configuration file. This safeguards against end-users accidentally altering the oven functionality or safe operating bounds.

The controller must be unlocked in order to access the Operations menu and enter calibration offsets.

Backing Up the Configuration File

The manufacturer recommends saving the controller configuration file prior to making any changes to Operations options. See the Configurator software description in the [Data Port](#) entry on page 50. This will allow you to restore the configuration file in the event a change is made that adversely affects the operation of the oven.

1

Navigate to the Lock menu.



Both



- Press and hold **both** the **Reset** and **Advance** buttons for approximately 8 – 9 seconds.

Note: If the top red line shows the “CUST” Custom option, use the **Up** or **Down** arrow buttons to scroll to the “Loc” Security Setting option. Then push the **Advance** button as per Step 2.



2

Advance to the lock “LoC.o” parameter.



- Push the **Advance** button once.

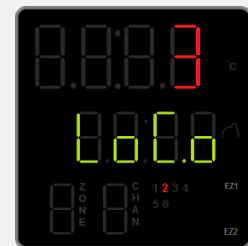

3

Adjust the LoC.o setting from 3 to 2.



- Push the **Down** arrow button.



Continued next page

Unlocking the Controller Continued

4

Advance to the second security parameter, “LoC.P”



- a. Push the **Advance** button once, saving the previous parameter and advancing to the next parameter.



5

Adjust the LoC.P setting from 2 to 3.



- a. Push the **Up** arrow button.



6

Advance twice. Skip through the “PAS.E” Password Enable parameter to “rLoc”, leaving “PAS.E” set to Off.



x2

- a. Push the **Advance** button twice.



Leave set to Off

7

Adjust the rLOC parameter from 2 to 5.



- a. Push the **Up** arrow button.



8

Advance to the “SLOC” Write Security parameter.



- a. Push the **Advance** button once.



Continued next page

Unlocking the Controller Continued

9



Change the “SLoC” parameter from 2 to 5.

- a. Push the **Up** arrow button.



10



x2

Return to the homepage to access the now unlocked Operations page.

- a. Push the **Reset** button twice.



Relocking the Controller

Always relock the controller after completing a calibration or other Operations menu procedure.

- To relock the controller, repeat the Unlocking procedure, only this time **restore** all of the Security lock parameters to the locked settings.
- When first navigating from the homepage to the Factory menu to relock the controller, the red top display line will show the “CUS^t” Custom option.
- Use the arrow buttons to scroll to the “LoC” Security option, then push the **Advance** button as per Step 2 and carry out the rest of the procedure.

Parameter	Locked	Unlocked	Parameter Function
LoC.o	3	2	Operations Page
LoC.P	2	3	Programming Page
PAS.E	Off	Off	Password Enable
rLoC	2	5	Read Lock
SLoC	2	5	Write Security

End of Procedure

HEATING ISSUES — DIAGNOSTIC QUESTIONNAIRE

If the unit is experiencing heating issues, use this questionnaire to gather information on the unit prior to contacting Technical Support. Gathering and sharing this information aids Tech Support in making timely and accurate remote diagnoses. Additionally, datalogger files as well as pictures and videos of the unit in its failure mode are valuable diagnostic resources that can be shared with Tech Support.

Overview

You will be performing the following tasks to gather onsite data:

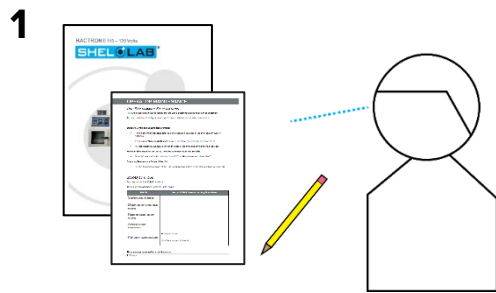

Verify the Unit Conditions using the procedure on page 61.

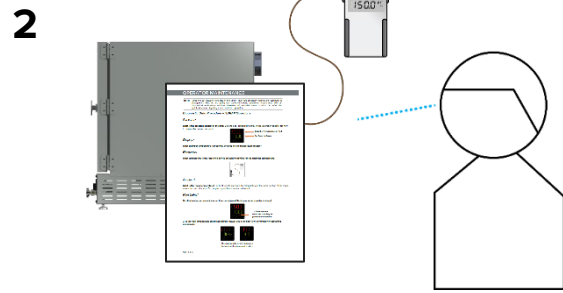

Read the Preparing topic on page 62, then observing the unit in operation using the SDRAP diagnostic questions on page 63.

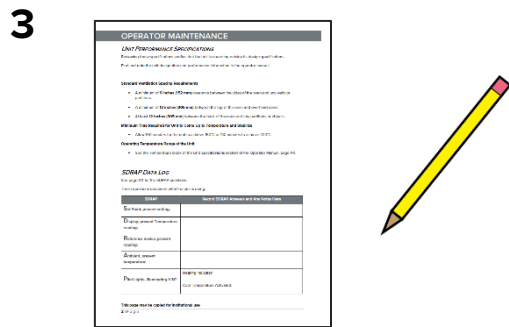

Record your observations in the SDRAP Answers Log on page 64.



Unit Model Information

Find the unit data plate (see page 17) and record the information on it below. This information is critical for accurate diagnoses as displays, gauges, valves, and port types vary based on the unit model and customization options.

MODEL NO:	
SERIAL NO:	
PART NO:	
PART ID:	

MAINTENANCE

Note: Does the car actually have gas in the tank? Have you physically verified the computer is plugged in? Yes, we are going to ask some very basic questions. Please bear with us. Methodical verifications and the elimination of potential failure causes are often the quickest means of getting a unit back into operation.

Verify the Unit Conditions

Verify the following items to make sure the unit is actually malfunctioning.

Condition Checks	Condition Data Location	Record Results Here
Ambient Conditions: Verify the room temperature falls within the required range.	See the Required Ambient Conditions topic on page 26 . Operating the unit outside the specified room temperature range will adversely impact its temperature performance.	The room temperature falls within the required range: Yes or No?
Spacing Clearances: Verify there is enough ventilation spacing around the unit.	See the Required Clearances topic on page 26 . Insufficient ventilation spacing may be adversely impacting temperature performance.	The oven has the minimum required clearance spacing around it: Yes or No?
Operating Range: Verify the oven is designed to achieve the temperature you are attempting to run it at.	See the unit Temperature Specs on page 72 . The oven will not operate outside the Range specification.	Are you attempting to operate the oven within the specified range: Yes or No?
Heat-up Time: Verify the oven has enough time to come up to temperature.	See the unit Temperature Specs on page 72 . The oven will not heat up faster than the stated Time to Temperature specifications.	The oven is being allowed sufficient time to come up to temperature: Yes or No?
Stability and Uniformity: Verify the unit is rated to provide the stability and uniformity you are attempting to achieve.	See the unit Temperature Specs on page 72 . The oven will not reliably achieve a better performance than the stated Uniformity and Stability specifications. *	You are attempting to achieve uniformity and / or stability matching the stated specifications: Yes or No?

* The oven may require time to achieve the specified temperature stability and uniformity after heating up to or cooling down to an operating setpoint. This is affected by the ambient conditions around the oven, the mass of the product or samples in the oven chamber, as well as the volume of outgassing taking place. The longer the oven has been operating, the more heat soaked it is. This generally shortens the time for the temperature to stabilize.

MAINTENANCE

Required Item: Temperature reference device. A calibrated digital thermometer with a vacuum-rated thermocouple feedthrough. The device must be accurate to at least 0.1°C.

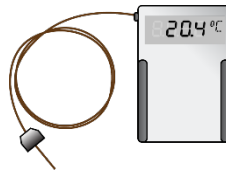

Preparing for the SDRAP Observations

1. The unit must be connected to a power source that meets the requirements in the Installation chapter (page 27) and turned on.



2. Secure the reference temperature device sensor probe at the center of the bottom shelf, with the probe head in direct contact with the shelf surface.

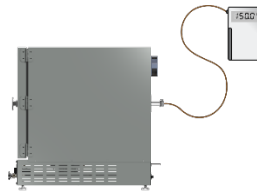

3. The oven chamber must be **empty, sealed,** and be **under vacuum.** See the [Place the Chamber Under Vacuum](#) entry on page 43.

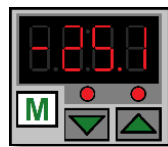

4. The unit must have adequate time to come up to temperature and stabilize. **Failure to wait will result in an inaccurate diagnosis.**



- See the oven Time to Temperature specifications on page 72.
- Start the Diagnostic Data Procedure **when the allotted time has passed**, even if the unit fails to achieve the setpoint temperature.

MAINTENANCE

SDRAP Diagnostic Questions

Record the answers in the log on page 64.

Setpoint?

What is the current temperature setpoint?

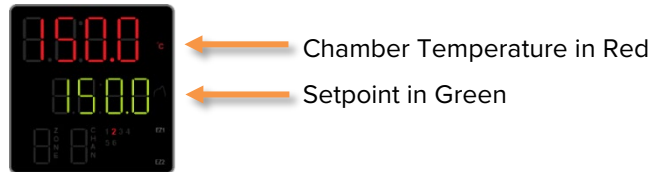

Display?

What chamber temperature is presently showing on the temperature display?

Reference?

What temperature is the reference device presently showing for the chamber temperature?

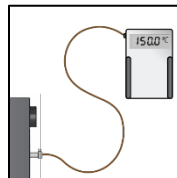

Ambient?

What is the current room temperature? For best results, measure the temperature in the same section of the room where the unit is located. Do not place your thermometer on the unit.

Pilot Lights?

1) Is the heating active indicator on the control panel flashing or otherwise illuminating, Y/N?



2) Is the High Limit cutoff active or has it activated recently, Y/N?



Alternating alert screens flash when the high limit heating cutoff is active.

SDRAP Answer Log

Record answers to the SDRAP questions in this log. These document the unit behavior.

SDRAP	Record SDRAP Answers and Any Notes Here
S etpoint, present setting:	
D isplay, present temperature reading:	
R eference device, present reading:	
A mbient, present temperature:	
P ilot Lights, illuminating Y/N?	Heating Indicator:
	High Limit Activated:

Other valuable diagnostic resources to share:

- Datalogger data
- Pictures and video of the unit in failure mode
- How long has the temperature issue been occurring?

Share!

Share the SDRAP and Unit Specifications data with Technical Support. This data is crucial for offsite personnel making accurate remote diagnoses and is used to help ensure technical support can resolve the issue.

Facilities Technicians

SDRAP and Unit Specifications data are also useful to any institutional repair technicians at your facility who may be responsible for servicing of out-of-warranty units.

This page may be copied for institutional use

End Diagnostic Data Procedure

MAINTENANCE

Vacuum Leak Issues – DIAGNOSTIC QUESTIONNAIRE

If the unit is experiencing vacuum leak issues, use this questionnaire to gather information on the unit prior to contacting Technical Support. Gathering and sharing this information aids Tech Support in making timely and accurate remote diagnoses. Additionally, datalogger files as well as pictures and videos of the unit in its failure mode are valuable diagnostic resources that can be shared with Tech Support.

Overview

You will be performing the following tasks to gather onsite data:

1

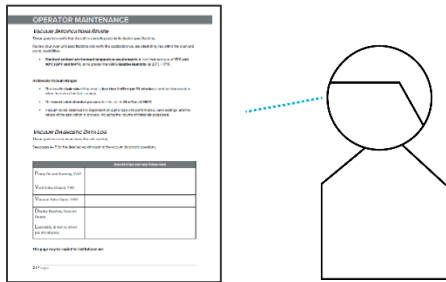

Verify the Unit Vacuum Conditions using the procedure on page 66.

2

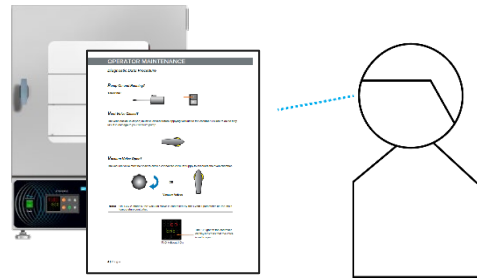

Read the Vacuum Diagnostic Setup topic on page 67, then observing the unit in operation using the Vacuum Diagnostic questions on page 68.

3

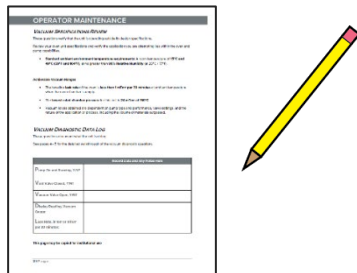

Record your observations in the Vacuum Diagnostic Data Log on Page 70.

4

Share the gathered information with Tech Support!

Unit Information

Find the unit data plate (see page 17) and record the information on it below. This information is critical for accurate diagnoses as displays, gauges, valves, and port types vary based on the unit model and customization options.

MODEL NO:	
SERIAL NO:	
PART NO:	
PART ID:	

Note: Does the car actually have gas in the tank? Have you physically verified the computer is plugged in? Yes, we are going to ask some very basic questions. Please bear with us. Methodical verifications and the elimination of potential causes of failure are often the quickest means of getting a unit back into operation.

Unit Vacuum Conditions

Verify the items below to ensure a fault in the oven rather than the pump or external vacuum plumbing or contamination is preventing the unit from achieving its specified performance levels. During normal operations, the oven can be vacuumed down to -3.0 to -29.9 inHg depending on the performance of the pump, the oven chamber temperature, and the volume of outgassed byproducts. For most applications, the vacuum pump must remain on and connected to the oven chamber to remove outgassed byproducts.

- Is the chamber being **quickly** pumped down to -3 inHg or lower? **Yes** or **No?**
 - The door will not seal completely at pressures higher than -3 inHg.
 - A slow evacuation may not be sufficient to seal the door.
 - The vacuum pump must be rated to a minimum flow capacity of 1 cubic foot per minute (cfm) per cubic foot of chamber volume. Example: a 2 cubic-foot chamber should be connected to a pump that can evacuate at least 2 cubic feet per minute.
- Is the vacuum pump type suitable for your application or process? **Yes** or **No?**
 - The vacuum pump must be resistant to byproducts outgassed during the baking process. Otherwise, the integrity of the pump can be quickly compromised.
- Is the gasket type suitable for the application? **Yes** or **No?**
 - Each gasket type is resistant to and vulnerable to different outgassed byproducts. A gasket that is vulnerable to byproducts from your applications may fail after only a short period of use.
 - See page 76 of the user manual to verify that the installed gasket is suitable for your application.
- Is the oven chamber clean prior to being pumped down? **Yes** or **No?**
 - Outgassing from contaminants can cause a rise in chamber pressure. At very low-pressure levels, the oven may register outgassing from fingerprints.
- Is the chamber being evacuated for the full duration of your baking application? **Yes** or **No?**
 - If the vacuum valve is closed during the baking application — isolating the chamber from the vacuum pump — outgassing from samples or products will raise the chamber pressure.

Vacuum Diagnostic Setup

1. Check the primary chamber gasket for damage. This is the gasket mounted either on the chamber liner or the door that seals the oven chamber when the door is closed.

Look for:

- Cuts or nicks on the gasket caused by removing shelves or samples from the chamber.
- Cracking, brittleness, or loss of elasticity.
- Discoloration of the gasket.
- Nicks or other damage on the surface the gasket seals against.



2. The unit must be connected to a power source that meets the requirements in the Installation chapter (page 27) and turned on.

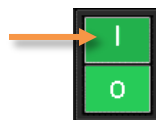
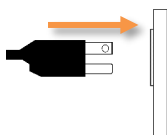

3. Do not heat the oven. The oven must remain at ambient temperature for this procedure.

4. The oven chamber must be **empty, sealed, clean,** and **under full vacuum draw.** See the [Evacuating the Oven Chamber](#) entry on page 43.

- Reminder: Outgoing products, samples, or contaminants such as fingerprints or spilled solvents will generate pressure and prevent the accurate diagnosis of a leak.

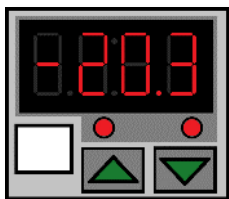

Vacuum Gauge

MAINTENANCE

Vacuum Diagnostic Questions

Pump On and Running?

Yes or no?

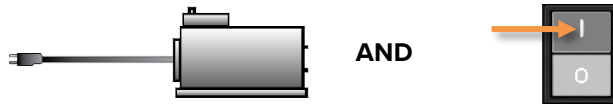

Vent Valve Closed?

The vent (backfill inlet port) must be closed before pumping down the chamber. Failure to do so may result in damage to your vacuum pump.

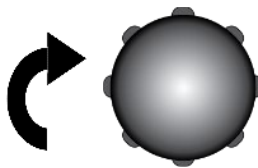

Vent Valve

Vacuum Valve Open?

The vacuum valve must be open to allow a connected vacuum supply to evacuate the oven chamber.

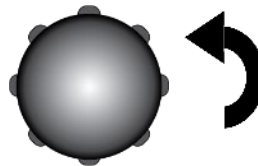

Vacuum Valve

Display Reading?

Record the chamber pressure level showing on the Vacuum Gauge display.

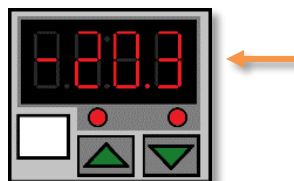

Reminder: Make sure to record the correct unit of measurement for the chamber pressure. See the [Vacuum Gauge Operations](#) topic on page 48 to verify the current unit of measurement.

Leak Rate?

Calculate and record the leak rate of the evacuated and isolated oven chamber:

1. Verify the oven chamber and shelving are at room temperature (20° – 25°C).
2. Verify the oven chamber is clean and dry to prevent outgassing from contaminants or water.
3. Close the chamber door, then open the vacuum valve.
4. Pump down the oven chamber to the lowest vacuum level your pump can achieve.
5. Write down the pressure displayed on the Vacuum Gauge as a positive number.
 - This is Record 1.

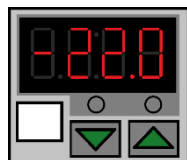

6. Isolate the chamber by closing the vacuum valve.

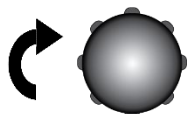

Vacuum Valve

7. Allow the oven to sit sealed and undisturbed for 30 minutes.
8. Write down the pressure displayed on the Vacuum Gauge.
 - This is Record 2.

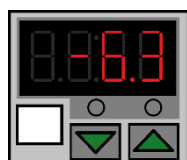

Leak Criteria

The oven chamber may be leaking if the chamber pressure rises by **0.1 or more during the 30-minute test** described above.

Vacuum Leak Diagnostic Data Log

Record the diagnostic question answers in this log. These questions document the unit behavior.

Diagnostic Questions	Record Answers and Any Notes Here
P ump On and Running, Y/N?	
V ent Valve Closed, Y/N?	
V acuum Valve Open, Y/N?	
D isplay Reading, Vacuum Gauge:	
V erified the oven is Leaking, Y/N?	

Other valuable diagnostic resources:

- Datalogger files
- Pictures and video of the unit in failure mode
- Time: How long has the vacuum issue been occurring?

Share!

Share the Vacuum Diagnostic Data Log and Unit Specifications data with Technical Support. This data is crucial for offsite personnel making accurate remote diagnoses and is used to help ensure technical support can resolve the issue.

Facilities Technicians

The Vacuum Diagnostic Data Log and Unit Specifications data are also useful to any institutional repair technicians at your facility who may be responsible for servicing out-of-warranty units.

This page may be copied for institutional use

UNIT SPECIFICATIONS

This oven is a 110 – 120 volt unit. Please refer to the oven data plate for individual electrical specifications.

Technical data specified applies to units with standard equipment at an ambient temperature of 25°C and at nominal voltage. The temperatures specified are determined in accordance with factory standard following DIN 12880 respecting the recommended wall clearances of 10% of the height, width, and depth of the inner chamber. All indications are average values, typical for units produced in the series. We reserve the right to alter technical specifications at all times.

WEIGHT

Model	Shipping Weight	Unit Weight
SVAC1	156 lb / 71 kg	102.0 lb / 47.0 kg
SVAC2	253 lb / 115 kg	182.0 lb / 83.0 kg
SVAC4	462 lb / 210 kg	317.0 lb / 144.0 kg

DIMENSIONS

Inches

Model	Exterior W × D × H	Interior W × D × H
SVAC1	17.5 x 23.0 x 23.7 in	9.0 x 12.0 x 9.0 in
SVAC2	20.8 x 31.3 x 26.8 in	12.0 x 20.0 x 12.0 in
SVAC4	27.0 x 35.2 x 32.8 in	18.0 x 24.0 x 18.0 in

Millimeters

Model	Exterior W × D × H	Interior W × D × H
SVAC1	444 x 584 x 602 mm	228 x 304 x 228 mm
SVAC2	528 x 795 x 681 mm	304 x 508 x 304 mm
SVAC4	686 x 895 x 833 mm	457 x 610 x 457 mm

CAPACITY

Model	Cubic Feet	Liters
SVAC1	0.56	15.9
SVAC2	1.67	47.2
SVAC4	4.50	127.4

UNIT SPECIFICATIONS

SHELF CAPACITY BY WEIGHT

Model	Per Shelf	Maximum Total Load	Max. No. Shelves
SVAC1	35.0 lb / 15.8 kg*	105.0 lb / 47.6 kg**	3
SVAC2	35.0 lb / 15.8 kg*	105.0 lb / 47.6 kg**	3
SVAC4	35.0 lb / 15.8 kg*	105.0 lb / 47.6 kg**	6

*35.0 lb / 15.8 kg with weight evenly distributed across the shelf.

**105.0 lb / 47.6 kg total load in the chamber. Exceeding this limit risks damaging the chamber liner.

VACUUM

Operational Vacuum Range

inHg	mmHg	kPa	bar
-3.0 to -29.9	-76 to -760	-10 to -101	-0.1016 to -1.0125

Vacuum Display Range

inHg	mmHg	kPa	bar
0.0 to -29.9	37.5 to -757	5 to -101	0.05 to -1.013

TEMPERATURE

Range and Uniformity

Model	Range	Uniformity
SVAC1	Ambient +10° to 220°C	±6.5% of Setpoint
SVAC2	Ambient +10° to 220°C	±6.0% of Setpoint
SVAC4	Ambient +10° to 220°C	±6.0% of Setpoint

Stability

Model	@80°C	@150°C	@220°C
SVAC1	± 0.1°C	± 0.10°C	± 0.3°C
SVAC2	± 0.1°C	± 0.20°C	± 0.3°C
SVAC4	± 0.2°C	± 0.25°C	± 0.3°C

Continued on next page

UNIT SPECIFICATIONS

Temperature performance continued

Time to Temperature: From an ambient temperature of 20°C

Model	Heat up to 80°C	Heat up to 150°C	Heat up to 220°C
SVAC1	40 Minutes	70 Minutes	120 Minutes
SVAC2	70 Minutes	120 Minutes	200 Minutes
SVAC4	70 Minutes	120 Minutes	230 Minutes

Cooldown Times: Time to cool down to 50°C

Model	From 80°C	From 150°C	From 220°C
SVAC1	90 Minutes	122 Minutes	181 Minutes
SVAC2	110 Minutes	188 Minutes	233 Minutes
SVAC4	161 Minutes	318 Minutes	420 Minutes





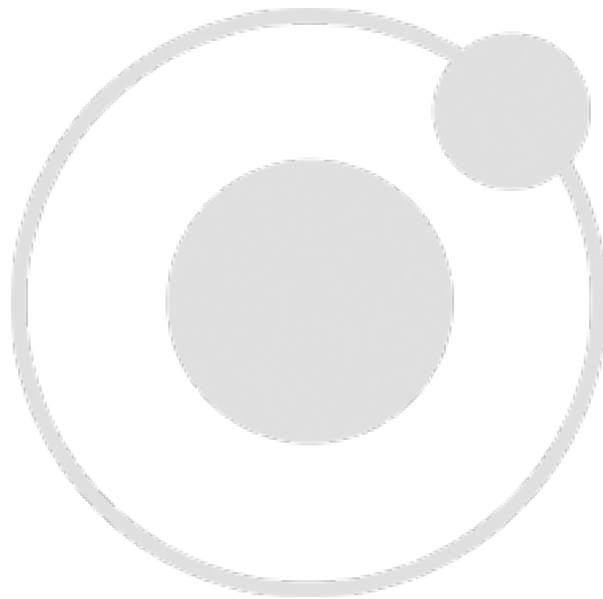

POWER

Model	AC Voltage	Amperage	Frequency
SVAC1	110 – 120	7.0	50/60 Hz
SVAC2	110 – 120	10.0	50/60 Hz
SVAC4	110 – 120	13.0	50/60 Hz

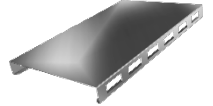

PARTS LIST

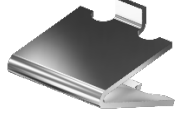
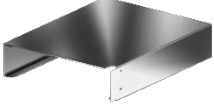
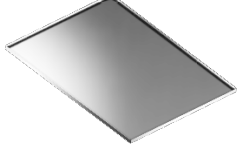
See the next page for gaskets

Description	Parts Number	Description	Parts Number
Adjustable Leveling Feet, SVAC2 & SVAC4	 2700506	Shelf Tall, SVAC2	 5680588
Fuse, T16A 250V 5x20mm	 3300513	Shelf Short, SVAC2	 9751342
Power Cord 125-volt, 15 Amp, 9ft 5in (2.86m) NEMA 5-15P	 1800510	Shelf Clip, Individual (1), SVAC4	 1250510
Shelf Tall, SVAC1	 5680506	Shelf, SVAC4	 5680563
Shelf Short, SVAC1	 5680519		

PARTS LIST

REPLACEMENT GASKETS

Available Gasket Types	Part Number
<p>Silicone, black or red, (comes with oven), rated to 230°C</p> <p>Applications: General and high temperature</p> <p>Resistant to: Moderate or oxidizing chemicals, ozone, and concentrated sodium hydroxide.</p> <p>Attacked by: Many solvents, oils, concentrated acids, and diluted sodium hydroxide.</p>	<p>SVAC1: 3450706</p> <p>SVAC2: 3450707</p> <p>SVAC4: 3450719</p>
<p>Buna-N rated to 125°C</p> <p>Applications: Solvent</p> <p>Resistant to: Many hydrocarbons, fats, oils, greases, and hydraulic fluids.</p> <p>Attacked by: Ozone, ketones, esters, aldehydes, chlorinated and nitro hydrocarbons.</p>	<p>SVAC1: 3450712</p> <p>SVAC2: 3450708</p> <p>SVAC4: 3450724</p>
<p>Fluorosilicone rated to 175°C</p> <p>Applications: Acidic</p> <p>Resistant to: Moderate or oxidizing chemicals, ozone, aromatic chlorinated solvents, and bases.</p> <p>Attacked by: Brake fluids, hydrazine, and ketones.</p>	<p>SVAC1: 3450610</p> <p>SVAC2: 3450611</p> <p>SVAC4: 3450612</p>
<p>Viton® rated to 205°C</p> <p>Applications: Acidic</p> <p>Resistant to: All aliphatic, aromatic and halogenated hydrocarbons, acids, and animal and vegetable oils.</p> <p>Attacked by: Ketones, low molecular weight esters, and compounds containing nitro.</p>	<p>SVAC1: 3450669</p> <p>SVAC2: 3450670</p> <p>SVAC4: 3450671</p>
<p>Gasket Dimensions</p> <p>SVAC1 – 9.2 x 9.3 Inches (229 x 229 mm)</p> <p>SVAC2 – 12 x 12 Inches (305 x 304 mm)</p> <p>SVAC4 – 18 x 18 Inches (457 x 457 mm)</p>	

Ordering

Accessories and replacement parts can be ordered online at parts.sheldonmfg.com.

If the required item is not listed online, or if you require assistance in determining which part or accessory you need contact SHEL LAB by emailing parts@sheldonmfg.com or by calling 1-800-322-4897 ext. 4 or (503) 640-3000 ext. 4.

Please have the **model**, **serial**, and **part** numbers and **Part ID** of the unit ready. Tech Support needs this information to match your unit to its correct part.

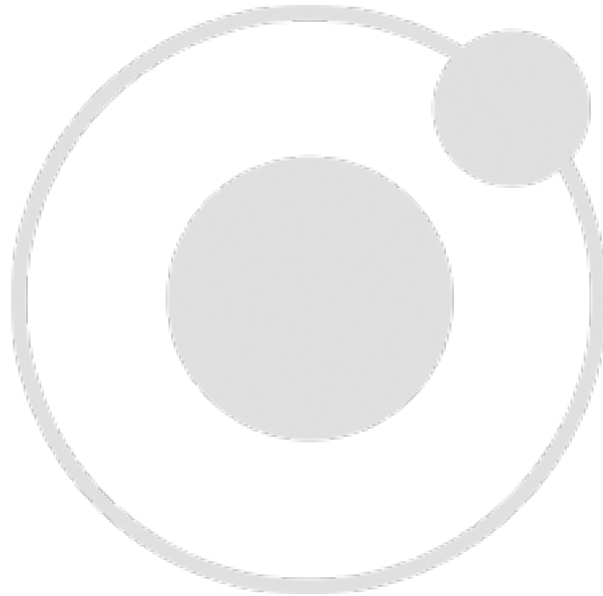



SHELDON
MANUFACTURING, INC

P.O. Box 627
Cornelius, OR 97113
USA

support@sheldonmfg.com
sheldonmanufacturing.com

1-800-322-4897
(503) 640-3000
FAX: 503 640-1366